

PLUS

Copyboard N-20S/N-20W/N-204

User's Manual

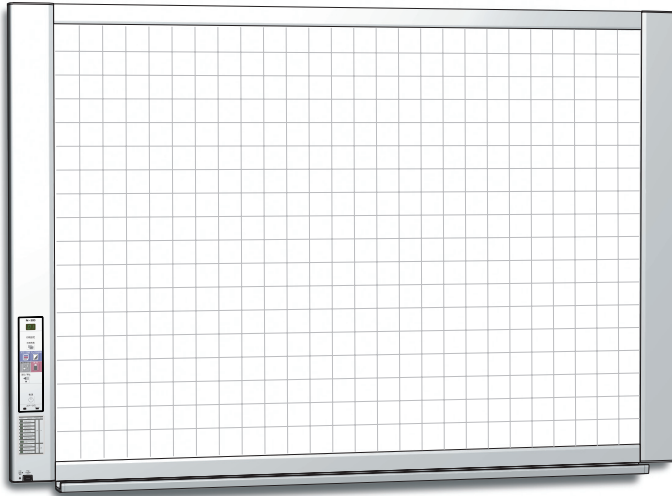

Thank you for your purchase of the PLUS Copyboard.
Please read this User's Manual carefully before use to take full advantage of the functions of this product. After you have finished reading the manual, please keep it for future reference.

Introduction

This manual is for the N-20S, N-20W, and N-204 models.

The N-20 copyboard exists in three types: the standard size (model N-20S), the wide size (model N-20W) and the 4-screen type (model N-204).

The descriptions and diagrams in this manual refer to the model N-20S.

* When functions or operations are specific to a certain model of copyboard, the model name is specified.

Cautions on using networks

About the network connection environment

- The required operating environment is subject to change without notice. Also, PLUS does not guarantee all operations.
- Even if all required operating environment conditions are met, it may happen that operations do not work properly or that some problems arise. Depending on the communications status, displays may be delayed and communication errors may occur.

Disclaimer

- PLUS will accept no responsibility whatsoever for any consequences of problems of communication impediments in connected devices due to the network functions.
- PLUS will accept no responsibility whatsoever for impediments incidental to usage of or the inability to use the network functions (loss of business profits, losses due to interruption of activities, etc.).
- PLUS will accept no responsibility whatsoever for malfunctions due to combinations with connected devices or the software used, nor for damages arising from hang-up, etc.

NOTE

Do not use ruled type tapes.

Do not move the sheet with tape, etc., attached to it. Doing so could result in malfunction.

Do not attach template sheets or paper to the sheet.

Do not copy while film-type objects or papers are attach to the sheet. Doing so could result in malfunction.

Trademarks

- Microsoft and Windows are registered trademarks or trademarks in the United States and other countries of the Microsoft Corporation.
 - Adobe and Adobe Acrobat Reader are trademarks of Adobe Systems Incorporated.
 - Safari, Apple, Mac OS and Macintosh are trademarks or registered trademark of Apple Computer, Inc., of the United States.
- The trademarks of the various companies and the product trademarks, even when not written down, will be given due respect. Product names and company names appearing in this manual are registered trademarks or trademarks of the respective companies.

- (1) The contents of this manual may not be reprinted in part or whole without permission.
- (2) The contents of this manual are subject to change without notice.
- (3) Great care has been taken in the creation of this manual; however, should any questionable points, errors, or omissions be apparent, please contact us.
- (4) Notwithstanding Section (3), this company will not be responsible for any claims of loss or profit or other matters deemed to be the result of using this unit.
- (5) The use of a printer as the peripheral device of the PLUS Copyboard is taken to be a prerequisite; therefore, operation will not be guaranteed when the printer is used with a direct connection to a personal computer.
- (6) Manuals with incorrect collating or missing pages will be replaced.

Table of Contents

Introduction	E-2	Transferring image files to/deleting them from the computer	E-27
Package Contents.....	E-4	When the folder for saving is set to “Board”	E-27
Names of the Parts	E-5	Deleting image files from the copyboard	E-29
Front	E-5	When the folder for saving is set to “FTP Server”	E-30
Input/output terminals	E-6	Deleting image files on the FTP server	E-31
Changing the Height of the Unit.....	E-7	CB Setup and Network Setting Procedure.....	E-32
Control Panel (Model N-20S/N-20W).....	E-8	CB Setup (operating the copyboard’s buttons)	E-32
Control Panel (Model N-204)	E-9	Basic setting operation	E-32
Functions of the Copyboard	E-10	Table of Function Numbers and Settings	E-33
Basic Functions.....	E-10	Simple Network Settings (via USB).....	E-35
Network Functions	E-10	Making Detailed Settings (via LAN)	E-37
Functions Specific to Model N-204	E-10	Basic Setting Operations.....	E-37
Operation Steps	E-11	CB Setup	E-40
Setting the Time.....	E-12	Header/Footer	E-41
Description of Operations	E-12	Network Setting	E-42
Printing (printer sold separately).....	E-14	User Setting	E-43
Preparing the Printer	E-14	Security Setting.....	E-44
Basic Printing Operation	E-15	Disk management Setting.....	E-45
Moving the sheet surface manually	E-17	CB Information	E-45
Printing Thumbnails (Model N-204)	E-17	Resetting the Network Settings	E-46
Consecutive Printing (Model N-204)	E-18	Creating and Registering Headers and Footers ..	E-47
Using USB Memory	E-19	Meaning of Error Messages	E-48
USB Memory Storage Procedure	E-19	Troubleshooting	E-50
Saving Image Files on a Computer/Deleting Image Files	E-21	Specifications	E-52
Using the copyboard connected to a computer	E-23	Appendix	E-53
Using the Copyboard Connected to a Network.....	E-25	Connections and Wiring Diagram	E-53
Saving scanned images on the copyboard or FTP server.....	E-25		

Meaning of the Terms Used in this Manual

- Main unit (or set): This refers to the copyboard.
- USB memory: refers to USB flash memory.
- USB memory storage: means the saving of sheet surface data using MEMORY (i.e., the USB port) of the operation panel.
- Memory for computer storage: indicates a temporary saving location of the image that has been read.
- “copy”: Both “print” and “USB memory saving” mean to “copy.”
- “Sheet surface”: refer to the drawing portion.
- “Scroll” or “move”: indicates feeding of the sheet
- Memory for network storage: Memory used for network storage.
- Network: The communications network on which devices are interconnected in net fashion for communication (exchange of data) between the devices. For this copyboard, the “network” indicates the LAN below.
- LAN (Local Area Network): A closed communications network for communicating within a restricted area, such as within a company.
- FTP (File Transfer Protocol): The protocol (communications rules) used when transferring files on a TCP/IP network.

Package Contents

The package contents are as described below. Please check before use.

Main unit [1]

Printer* [1]

Please see the instruction manual of the printer for information about the printer accessories.

* Depending on the type of product you have purchased, the printer may be sold separately.

Stand [1]

A mobile stand (with casters) for supporting the main unit. A printer table and AC adapter box are included. For the contents of the stand's package and instructions on assembly, see the stand's instructions or the separate Assembly and Setup Manual.

Pen tray [1]

Pen tray fixing screws (M4 × 20) (temporarily fastened on main unit)

N-20S/N-204: 3 screws, N-20W: 4 screws

(See the Assembly and Setup Manual for assembly instructions.)

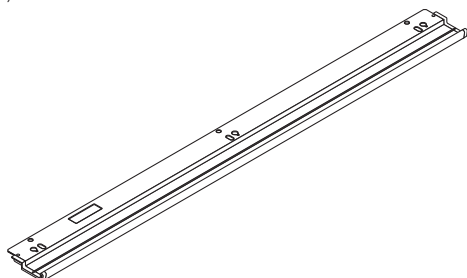

Wall mount printer table [1 set]

Bracket fixing screws (M4 × 8): 4

AC power adapter box: 1

Velcro: 2 sets

* Sold separately.

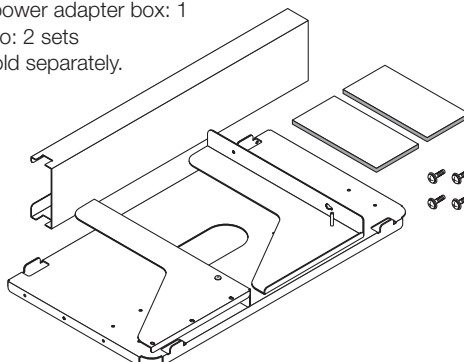

Wall brackets [1 set]

These are brackets for mounting the main unit on a wall. (See the Assembly and Setup Manual.)

Upper wall brackets: 2

Lower wall brackets: 2

Main unit fixing screws (M4 × 12): 2

* Sold separately for some products.

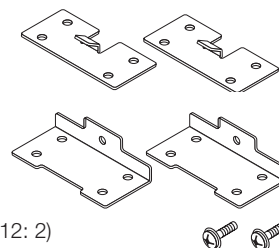

Copyboard Accessories

Dedicated markers

(One each of black, red, blue, and green)
Use these markers to draw on the sheet surface.

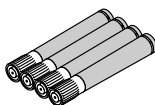

Dedicated eraser [1]

Use this to erase the drawing.

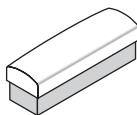

AC power adapter (with power cord) [1]

This is the power adapter for supplying power to the copyboard (See Page E-53).

(LTE36E-S2-3)

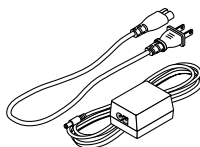

Notice

- The included AC power adapter and AC power cord are exclusively for use with this unit. Never use them with other products.

USB cable (type B ↔ type A) [1]

[PLUS code 715258900]

Cable for connecting the main unit to a computer.

Used for making the device settings.

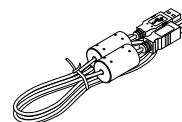

Notice

- Do not use this cable for connection to the printer (sold separately).

Documents

CD-ROM [1]

Includes the User's Manual (this manual) in PDF format.

The User's Manual contains instructions on using the copyboard.

Important Safety Information [1]

Includes instructions to be heeded in order to use the set safely.

Assembly and Setup Manual

Includes instructions on installing the set and connecting it with the printer (sold separately).

Names of the Parts

Front

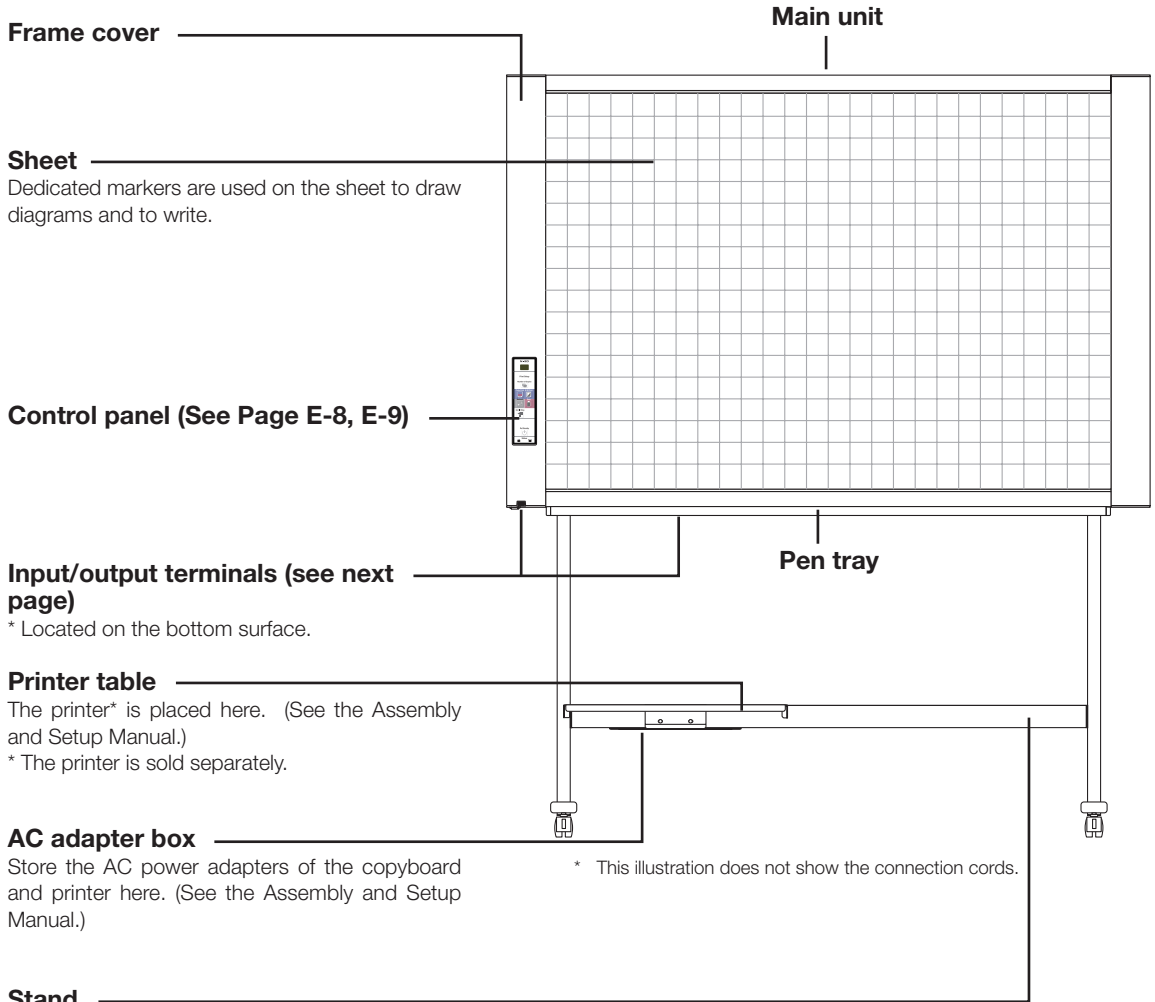

Frame cover

Sheet

Dedicated markers are used on the sheet to draw diagrams and to write.

Control panel (See Page E-8, E-9)

Input/output terminals (see next page)

* Located on the bottom surface.

Printer table

The printer* is placed here. (See the Assembly and Setup Manual.)

* The printer is sold separately.

AC adapter box

Store the AC power adapters of the copyboard and printer here. (See the Assembly and Setup Manual.)

Stand

This stand supports the copyboard. (See the Assembly and Setup Manual.)

Main unit

Pen tray

* This illustration does not show the connection cords.

* Depending on the product you have purchased, the printer may be sold separately.

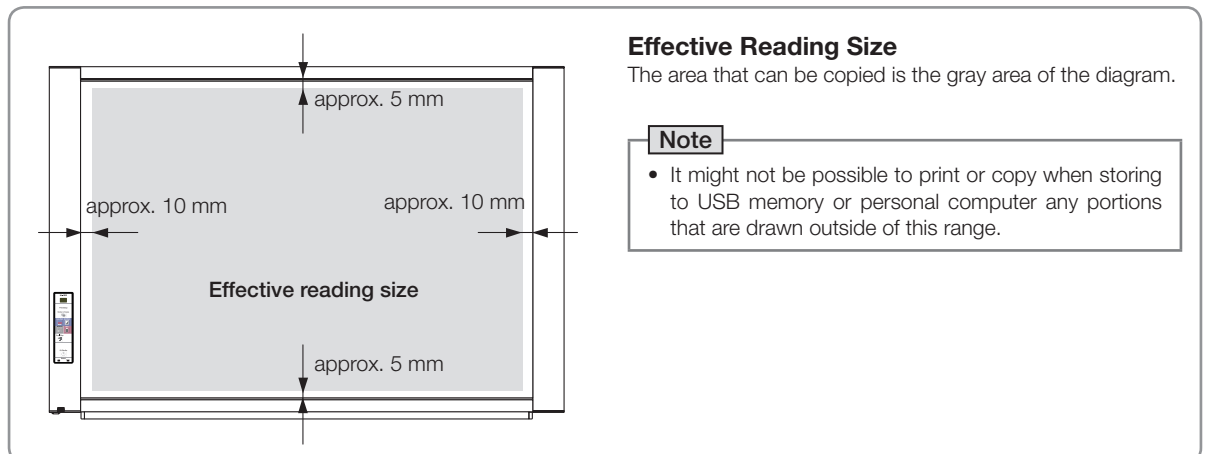

Effective Reading Size

The area that can be copied is the gray area of the diagram.

Note

- It might not be possible to print or copy when storing to USB memory or personal computer any portions that are drawn outside of this range.

Names of the Parts

Input/output terminals

USB memory port (type A)

Insert a commercially available USB memory device here. Scanned images can be saved. (See page E-19)

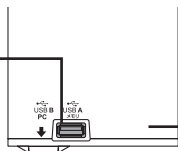

The connector is located on the bottom surface of the main unit.
The diagram view is seen from the bottom.

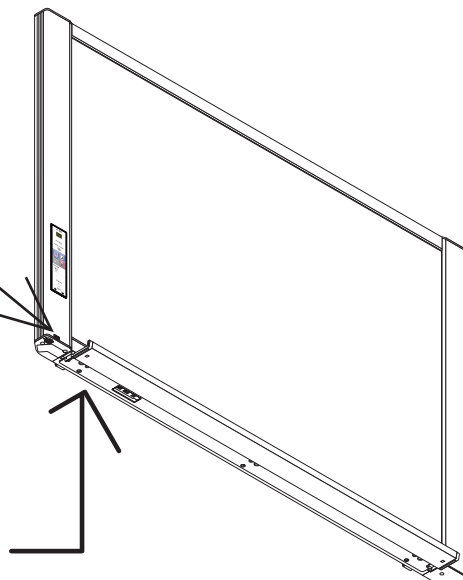

* This illustration does not show the printer or connection cords.

Personal computer (PC) dedicated USB port (Type B)

Connect this with the USB port (type A) of the PC. Used to connect the copyboard to a computer to make the copyboard's device settings. Can also be used to copy scanned images onto the computer. (See page E-23, E-35.)

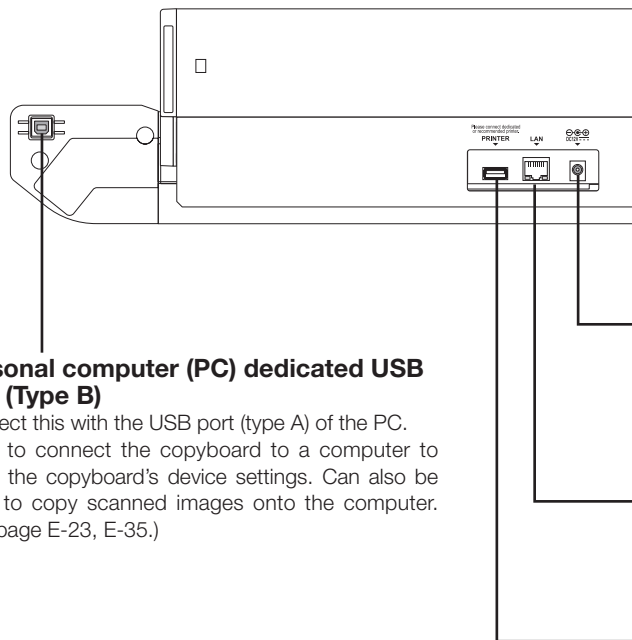

DC input connector

Connect this with the DC plug end of the AC power adapter. (See Page E-53.) (Only connect the supplied AC power adapter; nothing else.)

LAN terminal (RJ-45)

Connect to a LAN port on the network (switching hub, etc.) using a commercially available LAN cable.

Printer connector (USB port Type A)

Connect this with the USB connector of the printer (See Page E-53).
(The printer connector is dedicated for use with a printer; use it only with a printer.)

Locking/unlocking the stand's casters

After installation, lock the casters with the stoppers. When moving the stand, unlock the caster's stoppers. The stoppers are locked when the bottom is pressed. Press the top to unlock them.

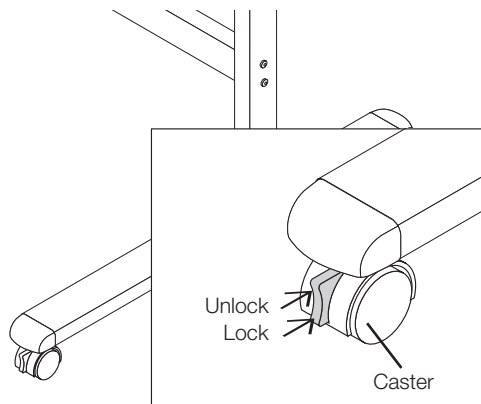

Changing the Height of the Unit

This is the height adjustment when setting up the copyboard on the optional stand. The stand height can be adjusted to 3 levels by 100 mm.

CAUTION

- At least two persons should hold the main unit. If not, the main unit could drop or tip, resulting in accidental injury.
- Lock the stand's casters by pressing the bottom of the caster lock button. If not, the stand could move while the main unit is being mounted or removed, resulting in accidental injury.
- After unplugging the power cord from the wall power outlet, disconnect all the connection cords from the set's input/output terminals. If the set is removed without disconnecting the cords, it could tip, resulting in accidental injury.
- If a printer is mounted on the set, remove the printer before starting. If not, the stand could tip while the main unit is being mounted or removed, resulting in accidental injury due to the printer dropping or tipping over.

(1) Unplug the power cord from the wall power outlet, then disconnect all the connection cords from the main unit.

(2) Remove the locking knobs (one on each side).

(3) Change the position of the main unit support pieces.

Lift the main unit about 1 cm to unhook it.

Insert the stand's hooks securely into in the mounting holes in the main unit's support pieces (one on each side).

(4) Fasten the two locking knobs (left and right) to the mount support pieces.

(5) Connect all the connection cables.

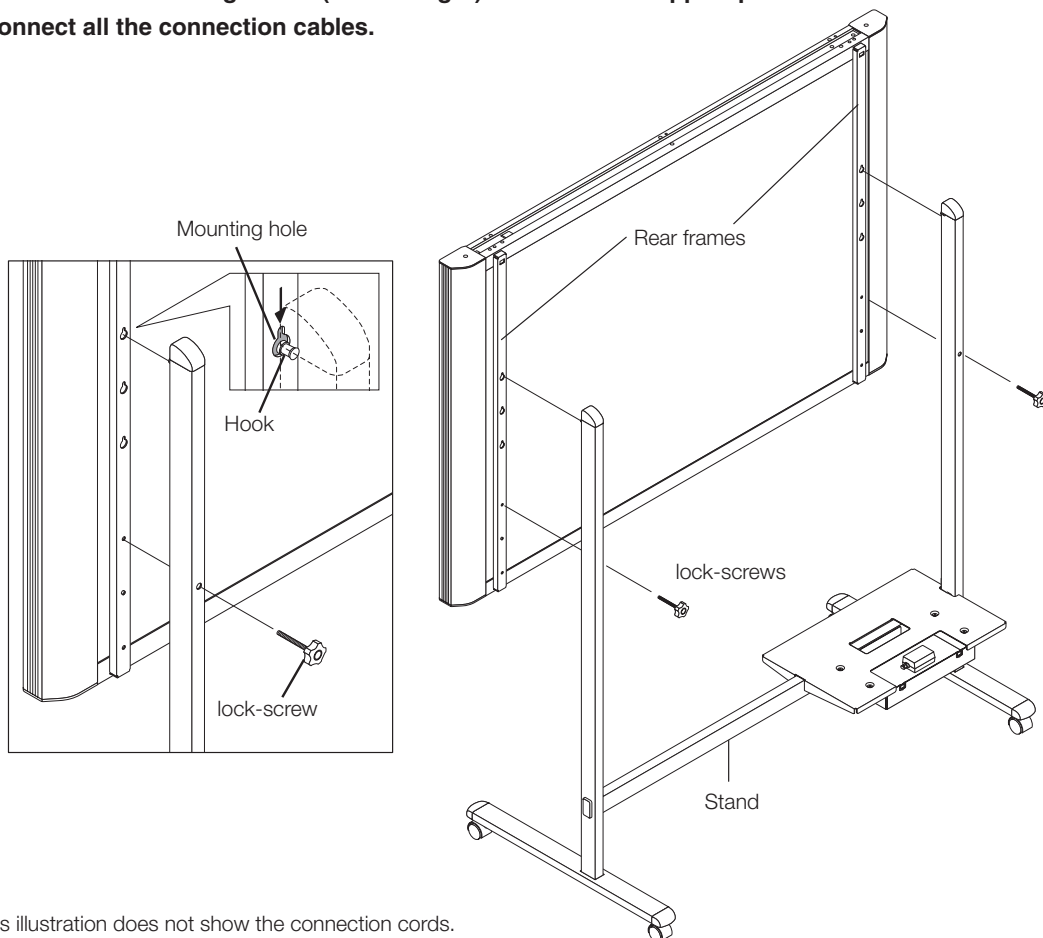

* This illustration does not show the connection cords.

Control Panel (Model N-20S/N-20W)

When pressing a button, please press the center area (the square bulge). The button may not work if it is pressed on a corner.

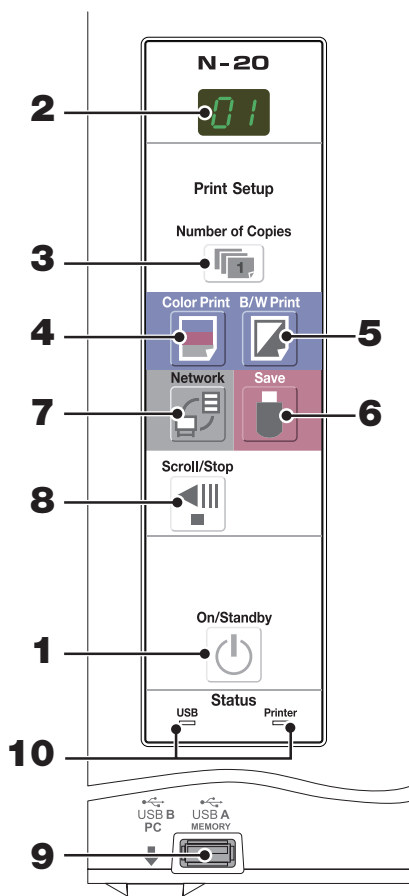

1 ON/Standby (⏻) button

Turns the copyboard's power on and off (standby mode).

2 Display window

The number of copies, operating status and error messages are displayed on the 7-segment LEDs.

3 Number of Copies (📄)/Test print button

Press this button to set the number of copies to be printed (max. 10). The number of copies is displayed on the display window.

* " P " is displayed during test printing.

4 Color Print (🖨️) button

The sheet is moved by 1 screen and read, and the image is printed in color in the number of copies indicated on the display window.

5 B/W Print (🖨️) button

The sheet is moved by 1 screen and read, and the image is printed in black and white in the number of copies indicated on the display window.

6 Save (💾) button (USB memory storage)

The sheet is moved by 1 screen and read, and the image is stored on the USB memory device.

When connected to a computer by USB cable, the image is stored in the copyboard's internal memory.

7 Network (🌐) button

Scrolls and scans the sheet one screen's worth and saves the data in the folder for saving.

The data is saved either on the copyboard or in a folder on the FTP server, as previously set.

8 Scroll/Stop (⏪) button

Scrolls the sheet one screen portion left, then stops automatically. A press of this button while scrolling will stop the scrolling.

9 USB A Memory port (USB Type A)

Saves in commercially-available USB memory images that have been read by the copyboard.

10 Status

These indicators notify of errors in the copyboard, USB memory device, network or printer according to whether they are lit or off and how they light (see table below). When the copyboard is functioning properly, the status indicators are lit green. (See table below)

Also check the error message on the display window.

For error information and remedies, see page E-48.

Display window	Meaning	USB indicator	Printer indicator
E1	Printer problem	Off	Lit red
EL	An unsupported printer is connected		
E2	USB Memory not recognized	Lit red	Off
E3	USB Memory storage problem		
U5	USB memory not connected		
FL	Memory is full	Lit red	Off
U5b	Warning that disconnection of USB memory has been forgotten		
E4	Reading error	Flashing red	Flashing red
E5	System error		
EH	Time setting error	Off	Off
EB	Security protection		
E9	Color printed prohibited		
L1	LAN cable disconnected		
L2	FTP server recognition error		
L3	FTP server connection failure		
L4	FTP server writing failure		
L5	Network or other error		
LE	Network setting reset error		
HE	Header/footer writing error		

* The letters "USB" scroll on the display.

Names of the Parts

Control Panel (Model N-204)

When pressing a button, please press the center area (the square bulge). The button may not work if it is pressed on a corner.

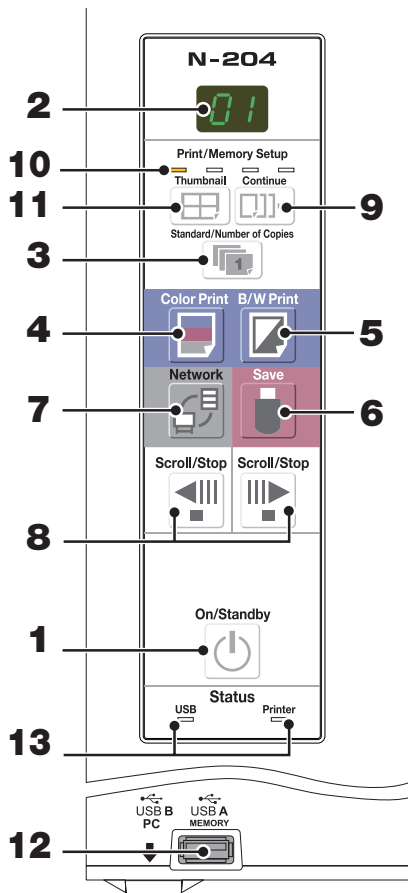

1 ON/Standby (⏻) button

Turns the copyboard's power on and off (standby mode).

2 Display window

The number of copies, operating status and error messages are displayed on the 7-segment LEDs.

3 Number of Copies (📄)/Test print button

Press this button to set the number of copies to be printed (max. 10). The number of copies is displayed on the display window.

* " P " is displayed during test printing.

4 Color Print (🖨️) button

The sheet is moved by 1 screen and read, and the image is printed in color in the number of copies indicated on the display window.

5 B/W Print (🖨️) button

The sheet is moved by 1 screen and read, and the image is printed in black and white in the number of copies indicated on the display window.

6 Save (💾) button (USB memory storage)

The sheet is moved by 1 screen and read, and the image is stored on the USB memory device.

When connected to a computer by USB cable, the image is stored in the copyboard's internal memory.

7 Network (🌐) button

Scrolls and scans the sheet one screen's worth and saves the data in the folder for saving.

The data is saved either on the copyboard or in a folder on the FTP server, as previously set.

8 Scroll/Stop (⏪) button

When the ⏪ button is pressed, the sheet scrolls one screen's worth to the left (to the next screen) and stops automatically.

When the ⏩ button is pressed, the sheet scrolls one screen's worth to the right (to the previous screen) and stops automatically.

When pressed during scrolling, scrolling stops.

9 Continue (⏩) button

Used to select the number of screens when printing or storing multiple screens consecutively.

10 Consecutive printing number indicators

These light yellow to indicate the number of screens selected with the consecutive button.

11 Thumbnail (🖼️) button

Used to select the layout for printing thumbnails of multiple screens on a single page.

The selected layout is indicated on the display window. (Page E-17, "Printing Thumbnails")

12 USB A Memory port (USB Type A)

Saves in commercially-available USB memory images that have been read by the copyboard.

13 Status

These indicators notify of errors in the copyboard, USB memory device, network or printer according to whether they are lit or off and how they light (see previous page). When the copyboard is functioning properly, the status indicators are lit green. (See previous page)

Also check the error message on the display window.

For error information and remedies, see page E-48.

Functions of the Copyboard

Basic Functions

① Printing

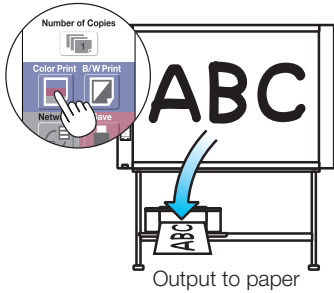

② Storing on USB memory devices

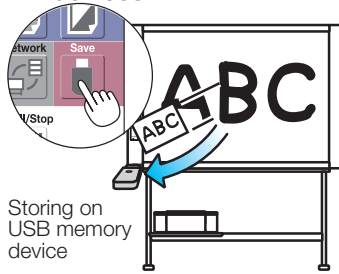

③ Capturing images on a computer

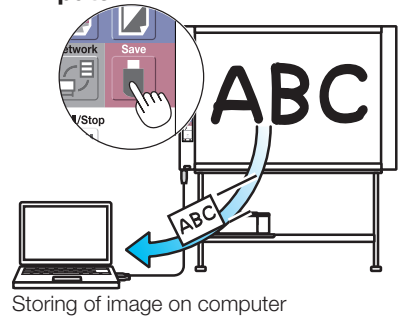

Network Functions

④ Viewing images stored on the copyboard via a network

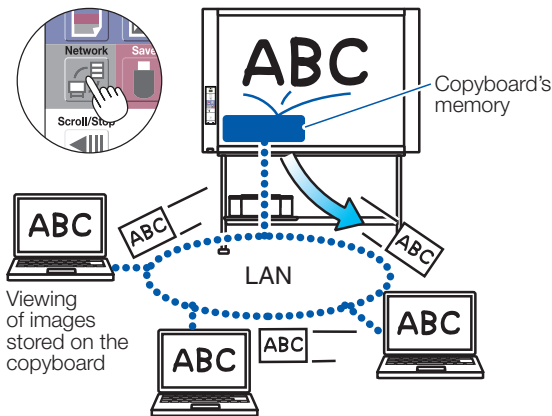

⑤ Viewing images stored on an FTP server via a network

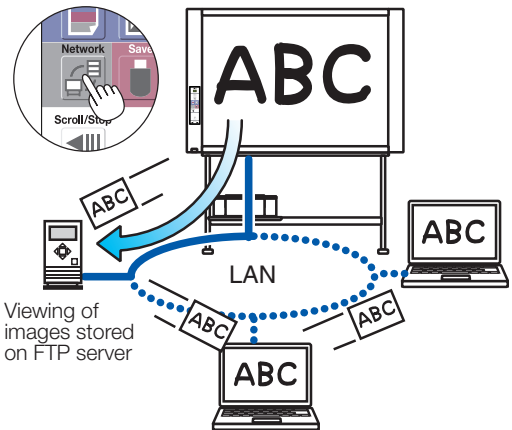

Functions Specific to Model N-204

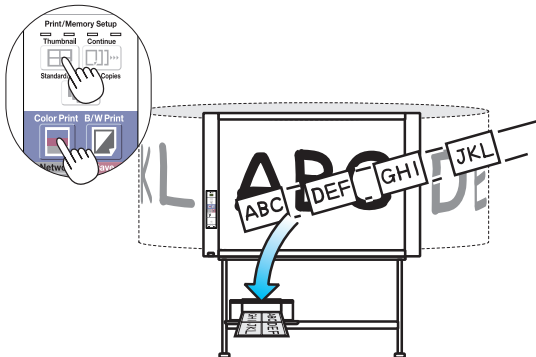

⑥ Printing thumbnails of multiple screens on a single page

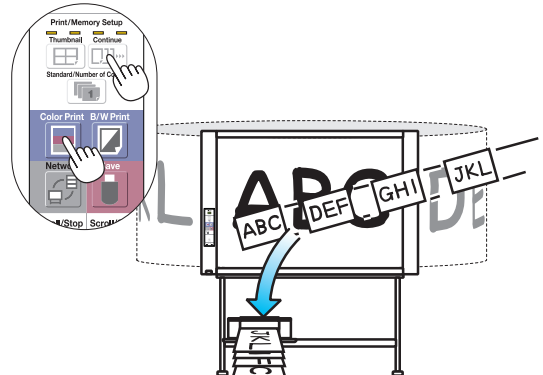

⑦ Printing or storing multiple screens consecutively



Operation Steps

The copyboard uses an image scanner to scan characters or diagrams drawn using special markers (four colors). When the Color Print  or B/W Print  button is pressed, the image on the screen is printed out to the printer. When a USB memory device or computer is connected, the image on the screen is saved as image data when the Save  button is pressed. (For the memory for computer storage, one sheet's worth of data is saved, overwriting previously saved data.)

Furthermore, when network settings are made, image files can be saved on the copyboard or FTP server.

Preparation

- **Set up the newly purchased copyboard and connect a printer.**
See a separate manual titled "Assembly and Setup Manual."
- **Plug the AC power plugs of the copyboard and printer into wall power outlets.**
- **After purchase, be sure to set the copyboard's clock. If not, the proper date and time will not be displayed on prints or in image files. See page E-12.**



Draw on the Sheet Surface

Please draw with the dedicated markers that have been supplied.

If anything other than the dedicated markers or eraser are used, it may be impossible to erase the sheet or the sheet could get dirty.



To move the sheet manually, see "Moving the sheet surface manually" on page E-17.

Printing

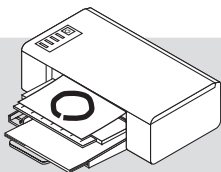
- (1) Set A4 or letter size paper.
Do not set anything other than A4 or letter size paper.
- (2) Press the ON/Standby  button of the copyboard and switch on the power.
- (3) Switch on the printer power.
For instructions on operating the printer, see the printer's operating instructions.
- (4) Press the Color Print  or the B/W Print  button. The copyboard will move a one-screen portion of sheet, read the image, and start the copy operation*. See "Printing" on Page E-14.





Saving to USB Memory

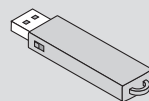

- (1) Press the ON/Standby  button of the copyboard to switch on the power.
- (2) Insert USB memory into the Memory  port (USB A port) of the copyboard.
- (3) Press the Save  button.
See "Using USB Memory" on Page E-19.



Saving on a computer

- (1) Press the copyboard's ON/Standby () button to turn the power on.
- (2) Connect the copyboard to the computer using the PC dedicated USB port.
- (3) Press the Save () button.
- (4) The image is saved on the computer.



Using a network (via LAN)

- (1) Check that the copyboard is connected to a LAN port on the network.
- (2) Press the copyboard's ON/Standby  button to turn on the power.
- (3) Press the Network  button.
See "Using the Copyboard Connected to a Network" on page E-25.

When Not Using the Copyboard

- (1) By all means, cleanly erase the drawing from the sheet surface with the dedicated eraser. (Leaving the drawing for a long period will make it harder to erase.)
- (2) Press the ON/Standby  button of the copyboard and switch off the power (standby mode).
The power cannot be switched off while the USB memory remains installed. (This is a prevention function against forgetting to unplug the USB memory.)
- (3) Switch off the printer power.

Note

- When turning on the power, wait about 5 seconds or more after the power plug has been connected before pressing the ON/Standby  button.
- The color of the images when printed in color or when saved in USB memory will differ somewhat from the marker colors.
- Blurred characters, thin lines, overlapping of markers and other factors can cause colors to differ in places and can also result in portions that cannot be scanned successfully.
- The data in the memory for computer storage is deleted when the ON/Standby  button is turned off (standby mode) or the connection with the computer is cut. The data in the memory for network storage is not deleted.



Setting the Time

The date and time are stamped on the printing paper and recorded in the file information when files are stored on the copyboard and FTP server, so set the copyboard's time correctly.
The time can also be set from a computer via a network (when connected to a LAN). (See page E-40.)

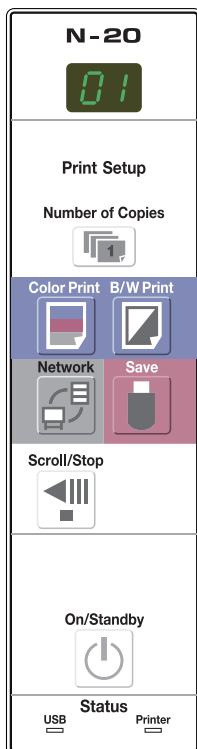
Description of Operations



1 Switch to "CB Setup".

With the power turned on, press the Number of Copies  button while pressing the ON/Standby  button, then release the ON/Standby  button.



2 Press the Save button and switch to "Time Setting".

The mode switches each time the Save button is pressed.
Contents of setting mode displayed on display window



(First 2 digits) (Last 2 digits)

Christian year Month Day Hours Minutes

3 Set the setting mode's date and time.

When the Color Print  or B/W Print  button is pressed once, the setting can be made.

Use the Color Print  (Increase) and B/W Print  (Decrease) buttons to set.



4 Press the Save button to enter the setting.

The copyboard switches to the next setting position.

Repeat steps 4 and 5 to set the current date and time.

- If the ON/Standby  button is pressed during steps 3 to 5, the partially made setting is canceled and the date and time return to the values set before the setting was started.

5 Complete the setting.

When the Save  button is pressed after the minute's setting position (c.6 display) has been set, the "Time Setting" is completed and the [F1] display (CB Setup) reappears. Press the ON/Standby  button to return to the normal mode.

Preparations :

Connect the power plug to a wall power outlet (AC 100–240 V).

[Example]: Setting the date and time to 2:16 pm October 8, 2011

1

Press the ON/Standby button to turn on the power.

The display window's LEDs light and the power turns on.

On/Standby



Normal mode

2

Press the Number of Copies button while pressing the ON/Standby button, then release the ON/Standby button.

The mode switches to "CB Setup", and "F1" is displayed on the display window's LEDs.

The mode returns to the normal mode if no buttons are operated for 10 seconds.

On/Standby



Number of Copies



"CB Setup" mode

Setting the Time

3

While "F1" is displayed, press the **Save** button to enter.

The display switches to "c1" (first 2 digits of year).

If no buttons are operated for 10 seconds while in the time setting mode, the mode returns to the "CB Setup" mode.

F1 → c.1



4

Press the **Save** button to move to the last digits of the year

The display switches to "c2" (last 2 digits of year).

Notice:

The first two digits of the year ("20") are fixed. Simply press the **Save** button to switch to the last 2 digits of the year setting position.

20



5

Use the **Color Print** (Increase) and **B/W Print** (Decrease) buttons to select "11" (the last 2 digits of the year), then press the **Save** button to enter.

The display switches to "c3" (setting of month).

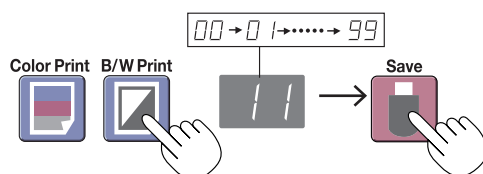

6

Use the **Color Print** (Increase) and **B/W Print** (Decrease) buttons to select "10" (the month), then press the **Save** button to enter.

The display switches to "c4" (setting of day).

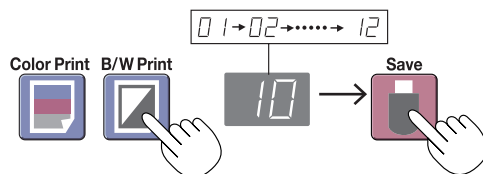

7

Use the **Color Print** (Increase) and **B/W Print** (Decrease) buttons to select "08" (the day), then press the **Save** button to enter.

The display switches to "c5" (setting of hours).

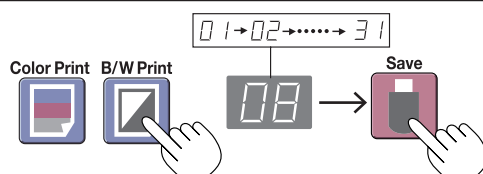

8

Use the **Color Print** (Increase) and **B/W Print** (Decrease) buttons to select "14" (the hours), then press the **Save** button to enter.

The display switches to "c6" (setting of minutes).

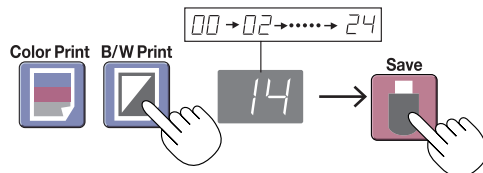

9

Use the **Color Print** (Increase) and **B/W Print** (Decrease) buttons to select "16" (the minutes), then press the **Save** button to enter.

The display switches to "F1" (function setting).

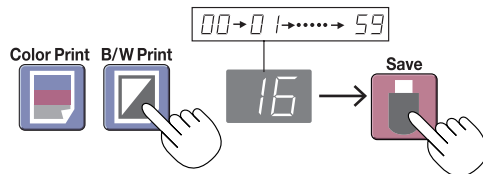

10

Press the **ON/Standby** button to return to the normal mode.

- The copyboard also returns to the normal mode if you just wait 10 seconds.

This completes the time setting.

F1 → 01
"CB Setup" mode Normal mode

Printing (printer sold separately)

Use a printer to print out the image that has been drawn on the sheet surface. Use a PLUS-designated printer. Operations and names of parts differ from printer to printer. For details of operations, see your printer's operating instructions.

Preparing the Printer

Please check that the copyboard and the printer have been connected. See Page E-53.

1

Set the paper.

Please use A4 or letter size printer paper.

- When using letter size paper, set letter size paper in the device settings. (See page E-33, E-40.)

- 1) Arrange the paper edges so that they are even.
- 2) Insert paper at the specified position of the paper tray.
- 3) Press the paper guide gently until it touches the paper.

Note

See your printer's operating instructions for a description of the paper that can be used.

Notice

- Depending on the printer's specifications, some time may be required for cleaning of the print head.

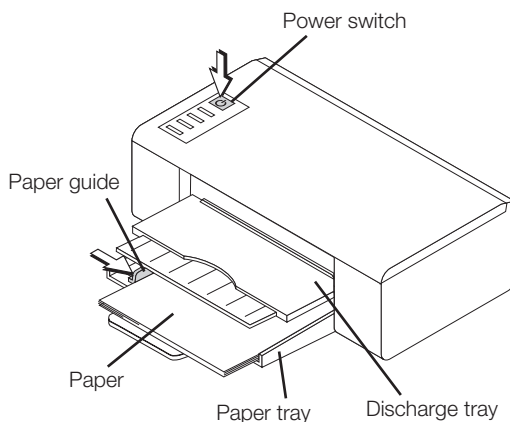



Appearance of printer is for illustration purposes.

2

Switch on the power.

Press the power switch. The power indicator lights.

This completes the preparation of the printer.

Press the Color Print  or the B/W Print  button on the copyboard's control panel. One page worth of data is read and the printing operation starts.

Notice

- Depending on the printer, indicators, etc., may flash after the power is turned until the printer is prepared to print. In this case, see the printer's operating instructions and check that the printer is ready before starting the printing operation on the copyboard.

3

When finished printing...

Switch off the printer power and remove the paper.
Close the paper tray.

Notice

- Caution: Do not turn off the power or disconnect the USB cable during printing.

Model name: N-20S/N-20W

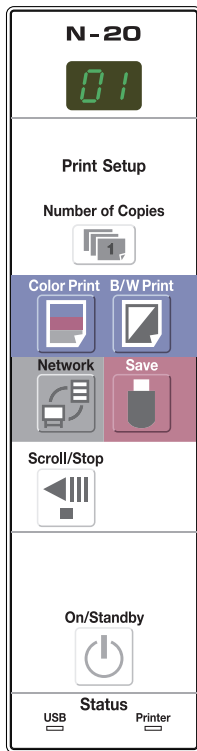

Basic Printing Operation

Preparation:



Preparation: Check that the AC power plugs of the copyboard and printer are connected to wall power outlets.

1 Press the ON/Standby  button and switch on the power.



Prepare the printer. (See the previous page.)

Note

- When turning on the power, wait about 5 seconds or more after the power plug has been connected before pressing the ON/Standby  button.
- Press the ON/Standby  button to switch on the power. The LED of the display window will light.
- Turn on the copyboard's power before turning on the printer's power.

2 Press the Scroll/Stop  button and display the sheet surface you want to print.

For models N-20S and N-20W

There are two screens.





A press of the Scroll/Stop  button scrolls the sheet surface one screen portion left and automatically stops it.

To stop the operation part way through, press the Scroll/Stop  button again.

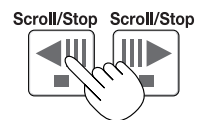

For model N-204

There are four screens.



When the Scroll/Stop  button is pressed, the sheet surface scrolls one screen's worth to the left (to the next screen) and stops automatically.

When the Scroll/Stop  button is pressed, the sheet surface scrolls one screen's worth to the right (to the previous screen) and stops automatically.

To stop during scrolling, press the Scroll/Stop  or  button again.

Note

- To display the next screen, press the Scroll/Stop button after scrolling stops. If the button is pressed during scrolling, scrolling stops immediately. When pressed again, the sheet is scrolled one screen's worth from the point at which it stopped.
- The one-screen that is visible is printable position.
- To fine-adjust the sheet surface position, with the sheet stopped, move the sheet slowly by hand. The sheet can be moved either to the left or to the right.
- Printing of the portion located around the sheet surface might not be possible. Please see "Effective reading size" on Page E-5.

Model name: N-204

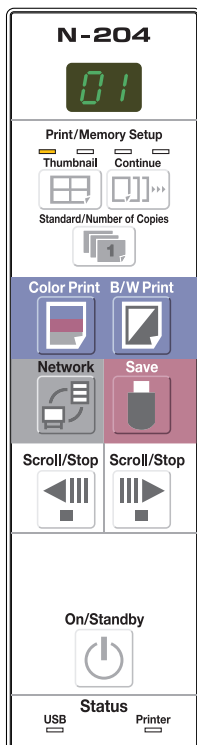

continued on next page

3

Press the Number of Copies  button and select the number of copies.



Note

- “01” is selected when the power is turned on.
- Up to 10 copies can be specified and displayed on the display window.
- The number of copies increases by 1 each time the Number of Copies button is pressed, and “ P” is displayed after “10” (this is used for test printing: see page E-51). When the button is pressed again, the display switches to “01”. The number switches continuously if the button is held in.
- After setting the number of copies, proceed to step 4 within 1 minute. The number of copies is reset to “01” if no operation is performed within 1 minute.

4

Press the Color Print  or the B/W Print  button to print.

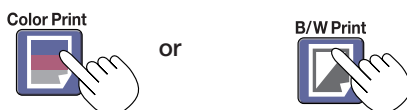

- The reading operation is performed for a one-sheet portion (while the sheet is scrolled) and the printing operation is performed.

Cancellation of the print operation in progress

When the ON/Standby  button is pressed, the reading of the sheet stops, and the partially read image data is printed. Wait until the sheet is expelled from the printer.

Note

- If the ON/Standby  button is pressed while the sheet surface is being read, printing is interrupted and only part of the image will be printed.
- The one-screen portion is reduced to A4 paper size and printed.
For wide type copyboards (model N-20W), the image is compressed about 75% in the horizontal direction. To print with the same proportions as the image on the sheet surface, see “Making the Device Settings” (page E-33).
- A flashing “E 1” in the display window indicates a print error. See “Meaning of Error Messages” on Page E-48.
- When printing, a time stamp (date and time) is printed at the top right of the sheet. See “CB Setup” on page E-32, E-40.

5

When the copyboard is not going to be used, press the ON/Standby  button and switch off the power (standby mode).



- Switch off the printer power.

Note

- When the Erase Reminder function is set to “Enable”
When the ON/Standby  button is pressed, the display window and all the indicators flash simultaneously, the sheet automatically moves to the surface that is not yet erased and the power turns off. To set the Erase Reminder function to “Disable”, see page E-34, E-40.
* The Erase Reminder function may not work properly due to dirt on the sheet's adhesive sections or marker residue.
- If no button is operated within 30 minutes, the power turns off automatically (auto power off).
When the power is turned off, scanned images stored in the unit's internal memory are cleared.
- The auto power off function is canceled when the copyboard and computer are connected by USB cable.



Moving the sheet surface manually

The sheet can be moved even when the power of the copyboard is switched off. The sheet can be moved with your hand either in left or right. Please place your hand at the vertical center and move the sheet slowly.

Notice

- Quick movement can cause damage to the drive mechanism of the copyboard.
- When the sheet surface is moved, roller traces may appear on parts of the screen.

Note

- When the Erase Reminder function is set to "Enable", the Erase Reminder function may not operate properly if the sheet surface is moved by hand.

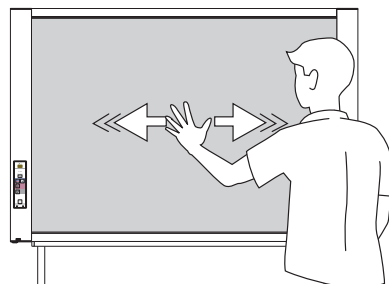

Printing Thumbnails (Model N-204)

Multiple screens from the screen at the current position can be printed on a single page.

- The thumbnail printing function is for printing only. Storing with the Save or Network button is not possible.

1. Press the Thumbnail button and select the page layout.

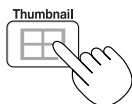

The mode switches in the following order each time the button is pressed.

Thumbnails of 2 screens → Thumbnails of 4 screens (horizontally) → Thumbnails of 4 screens (vertically) → Cancel ...

- The thumbnails are arranged in order from the currently visible screen, counted to the right as screen 1, screen 2, screen 3 and screen 4.

To start from a particular screen, press the Scroll/Stop or button to scroll to that screen.

Notice

- Note that if you have drawn on the sheet after moving it manually part way or after stopping scrolling in the middle, the amount of movement for one screen's worth changes, so the position of the scanned images will be substantially off.
- This product uses an endless sheet. Note that the position of the scanned images may go slightly off due to stretching of the sheet or slippage.

Display window status and page layout

Thumbnail selection	Movement of display window LEDs	Page layout
Thumbnails of 2 screens		
Thumbnails of 4 screens (arranged horizontally)		
Thumbnails of 4 screens (arranged vertically)		
Cancel (1 screen)		

2. Press Color Print or B/W Print button to print.

When one of the print buttons is pressed, the specified number of screens is collected sequentially in the scanning memory and thumbnail processing is performed. Printing starts after this processing is completed.

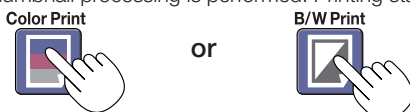

When printing is finished, thumbnail printing is canceled.

Note

- To print thumbnails of 3 screens, specify thumbnails of 4 screens (arranged horizontally or vertically).
- If there is a blank screen in the specified sequence, that screen is printed as a blank.
- If the ON/Standby button is pressed during scanning, scanning is interrupted and only the images that have been scanned are printed as thumbnails.

Consecutive Printing (Model N-204)

Multiple screens from the screen at the current position can be printed (or stored).

1. Press the Continue button and select the number of screens.

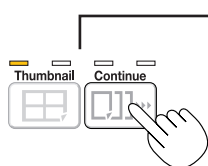

Consecutive printing number indicators





- One lit: Cancel (single-screen printing/storing)
- Two lit: Screens 1 and 2 printed/stored consecutively
- Three lit: Screens 1 to 3 printed/stored consecutively
- Four lit: Screens 1 to 4 printed/stored consecutively

The mode switches in the following order each time the button is pressed.

Screens 1 and 2 → Screens 1 to 3 → Screens 1 to 4 → Cancel ...

The number of consecutive screens is indicated by the number of consecutive printing number indicators that are lit yellow. ("CP" is displayed on the display window when consecutive printing is selected.)

* The screens are counted in order from the currently visible screen as screen 1, screen 2, screen 3 and screen 4. To start from a particular screen, press the Scroll/Stop  or  button to scroll to that screen.

Notice

- Note that if you have drawn on the sheet after moving it manually part way or after stopping scrolling in the middle, the amount of movement for one screen's worth changes, so the position of the scanned images will be substantially off.
- This product uses an endless sheet. Note that the position of the scanned images may go slightly off due to stretching of the sheet or slippage.

2. Press Color Print or B/W Print button to print.

When one of the print buttons is pressed, the screens are scanned and printed repeatedly until the specified number of screens has been scanned and printed.

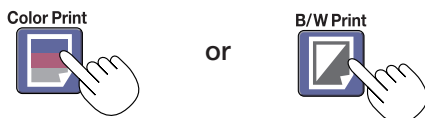

When printing is finished, consecutive printing is canceled.

Note

- If there is a blank screen in the specified sequence, that screen is printed as a blank.
- If the ON/Standby button is pressed during scanning, scanning is interrupted and only the images that have been scanned are printed.
- If printing of multiple copies has been specified (with the Number of Copies button), after scanning, the specified number of copies is printed, and this is repeated until the specified number of screens has been scanned and printed.

Using USB Memory

The content of what has been drawn on the sheet surface of the copyboard can be saved in USB memory. Later, the saved image can be read into a personal computer and made into a document of the proceedings of the meeting, or affixed to a document.

Notice

- No USB flash memory device is included. When purchasing a USB flash memory device, pay attention to the following:
 1. USB flash memory devices formatted in FAT16/FAT32 are supported. USB flash memory devices in NTFS format cannot be used.
 2. USB flash memory devices protected by a security function cannot be used.
 3. USB flash memory devices with a capacity of over 32 GB cannot be used.
 4. If the USB flash memory device is divided into multiple partitions, only one partition can be recognized with this unit.

USB Memory Storage Procedure

Preparation:

Check that the copyboard's AC power plug is connected to a wall power outlet.

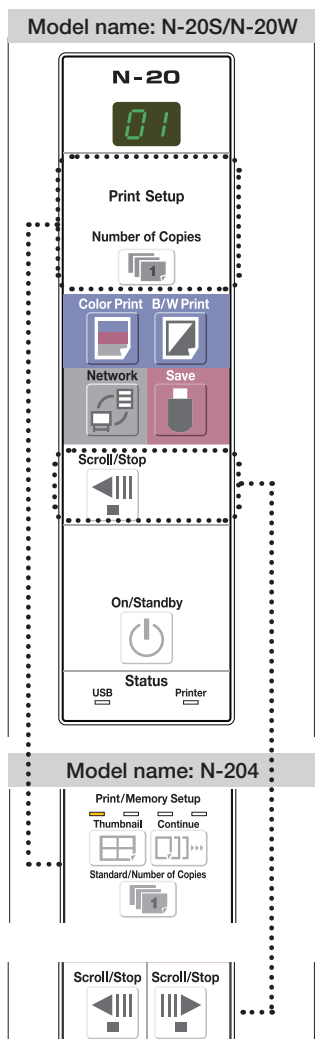

1

Press the **ON/Standby** button and switch on the power.



Note

- When turning on the power, wait about 5 seconds or more after the power plug has been connected before pressing the ON/Standby button.
- Press the ON/Standby button to switch on the power. The LED of the display window will light.

2

Insert the **USB memory device** into the **USB A Memory** port of the copyboard.

Notice

- Check the side (polarity) of the USB memory device before inserting it. Forcing it in the reverse orientation will damage the USB A Memory port or USB memory device.
- Be careful not to bump into the USB memory device with hand or body while it is mounted. Doing so could damage the USB memory device or USB A Memory port.

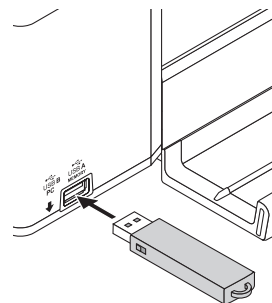

3

Press the **Scroll/Stop** button (for model N-204, the **Scroll/Stop** or **Scroll/Stop** button) to display the screen to be stored.

Model name:
N-20S/N-20W



Model name:
N-204

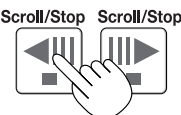

The procedure for displaying the sheet surface you want to store is the same as for printing.

See "Basic Printing Operation" on page E-15.

Note

- The one screen portion that is viewable will be saved in USB memory.
- Saving of the portion located around the sheet surface might not be possible. Please see "Effective reading size" on Page E-5.

4 Press the Save button to store.



Display window

Flashing indicator “rotates” sequentially during USB memory storage operation.

- The reading operation is performed for a one-sheet portion (while the sheet is scrolled) and USB memory storage starts after the scrolling completes.
- For model N-204, multiple screens can be stored consecutively. (See Page E-18, “Consecutive Printing”.)



The (5 second) flashing “US” display indicates that the USB memory has not been inserted. Please insert the USB memory and then press the Save button.



A (5 second) flashing “FL” display indicates that there is insufficient free capacity to permit storage in USB memory. Replace with a USB memory device having sufficient capacity. See “Meaning of Error Messages” on Page E-48 for other error displays.

Note

- Depending on the USB memory, it may take time for recognition or it may take time for saving.
- When the ON/Standby button is pressed during the reading operation, the reading operation will be discontinued and the partially read image data will be stored in the USB memory. To move the sheet surface, stop scrolling, then press the Scroll/Stop button (for model N-204, the Scroll/Stop button or button).
- The date and time of the saved file will reflect the copyboard time setting. See “CB Setup” on Page E-33.
- When a certain amount of free capacity is not available in the USB memory, “FL” will be displayed when the Save button is pressed. Delete data, set the sheet surface back to the original status, then press the Save button again.
- When the copyboard and a computer are connected by USB cable, the data is stored in the main unit’s internal memory.

5 Removing the USB memory

Check that the flashing rotation of the display window has changed to steady lighting and that the USB memory access indicator is not flashing, then pull the USB memory straight out. (Please see your USB memory manual for details.)

Notice

- Do not unplug the USB memory device during the USB memory storage operation (i.e., during the rotating, flashing display in the display window), or while the access indicator of the USB memory device is flashing because data will be destroyed.

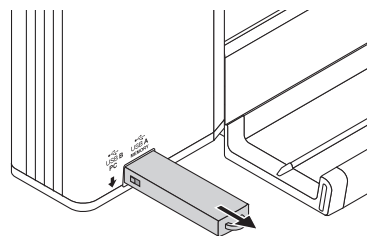

6 When the copyboard is not going to be used, press the ON/Standby button and switch off the power (standby mode).

On/Standby



Note

- “USB” letters appearing at one-second intervals in a moving display in the display window indicate that a USB memory device is mounted. Unplugging the USB memory device will switch off the power. (A function that serves as a reminder to unplug the USB memory device)
- When the copyboard and a computer are connected by USB cable, the auto power off function (which turns the power off automatically) is canceled.
- Scanned image files stored in the memory for computer storage are deleted when the ON/Standby button is turned off. Files in the memory for network storage are not deleted.

Saving Image Files on a Computer/Deleting Image Files

Examples of operations follow for saving the image files in the USB memory device to the hard disk of the personal computer, and for deleting the folder when the USB memory capacity is full. (There are various methods that can be used for saving and deleting including the use of Explorer.) See the instruction manual of your personal computer or the software that you are using for information about using a personal computer.

The name of the folder on the USB memory device is "CB_Image". Image files are stored in this folder. By factory setting upon purchase, image files are named "PV-xxx.jpg" (JPEG files), where "xxx" refers to a 3-digit number starting from 001 (ex.: PV-001.jpg).

When consecutive storing is performed on model N-204, numbers "-1", "-2", "-3" or "-4" are added to the end of the file name. (Example: When three screens are stored consecutively - PV-001-1.jpg, PV-001-2.jpg, PV-001-3.jpg)

Images can be stored in JPEG, PNG or PDF format, selectable in the copyboard settings ("CB Setup"). (See pages E-33, E-40.)

1

Plug the USB memory device into a USB port of the personal computer

When connecting to the personal computer for the first time, the installation of a USB driver is required. Follow the instructions manual of the USB memory device that you are using.

- Usually, with Windows XP/Windows Vista/Windows 7, the standard driver is installed automatically and the copyboard is identified as "Removable disk" in "My Computer" (or "Computer").

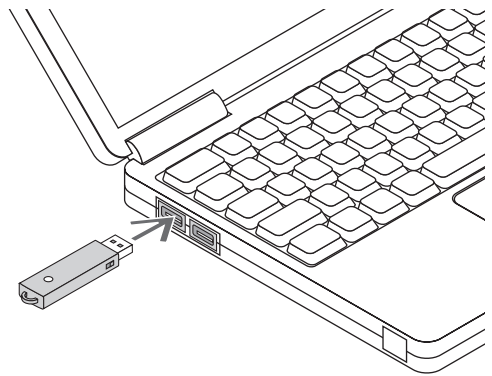

2

Saving the image files of a USB memory device to a personal computer

1. Open "My Computer" (or "Computer") and from within, open the drive of the connected USB memory device.

The folder named "CB_Image" is the saved data of the copyboard.

2. Store the "CB_Image" folder in "My Documents" or another location.

All of the data contained in "CB_Image" will be stored.

Notice

Depending on the computer's usage environment, these operations may not work properly. This could be the case for example:

- when several USB devices are connected simultaneously to the computer.
- when the USB device is connected to a USB hub or when it is connected using an extension cable.

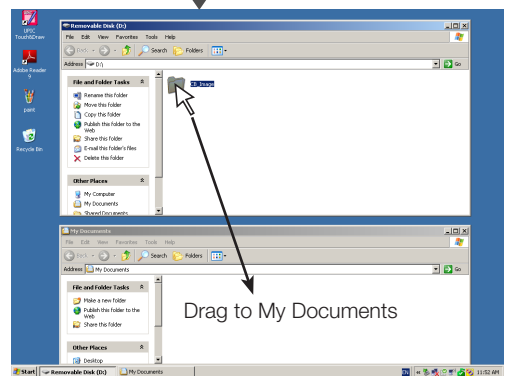
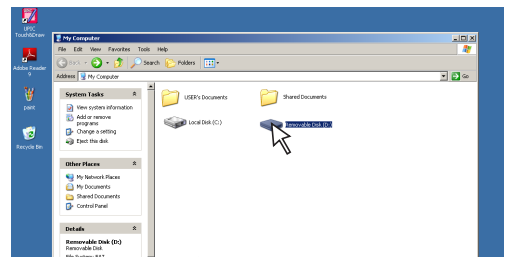

Deleting USB memory image files with the computer

Before deleting important image files, be sure to save them on the computer (as a data backup).

1. Open “My Computer (or “Computer”)” and then open the drive icon which shows USB memory.

The folder named “CB_Image” contains the memory storage data of the copyboard.

2. Place the “CB_Image” folder in the “Recycle Bin”, right click on the icon and select “Empty Recycle Bin” from the pull-down menu.

All of the data contained in “CB_Image” will be deleted.

Even when the entire folder is deleted, a new CB_Image folder will be created automatically when USB memory is used again with the copyboard.

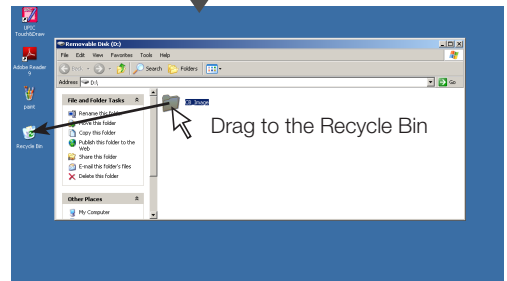
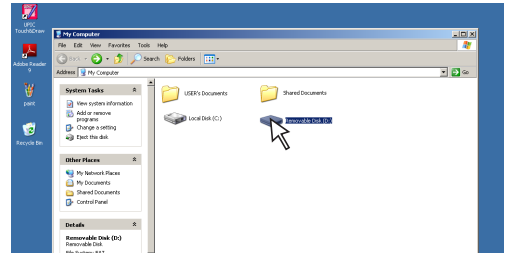

3

Disconnect the USB memory

The disconnecting procedure depends on the computer's operating system. For details, refer to the computer's operating instructions or help files.

1. Click the [Hardware Removal] icon that is displayed in the task tray.

Click “Stop USB Mass storage Device - drive (E)”. (The E drive character will differ depending on the personal computer system.)



“Remove hardware” icon (example)

2. When the “USB mass storage device can be safely removed.” screen is displayed, click the display.



3. Click [X] to close.

This allows the USB memory device to be unplugged from the computer.

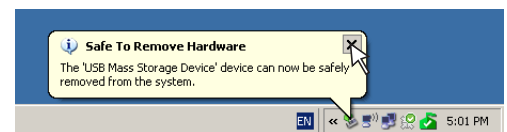

Note

- Do not disconnect the USB memory device while the USB memory device's access indicator is flashing. Doing so will damage the data.
- The USB drive may not be disconnected properly, for example if the computer is in the process of checking the status of peripherals.

Using the copyboard connected to a computer

When the copyboard and a computer are connected by USB cable, the copyboard is recognized as an external memory device (removable device). Below is the procedure for copying the “CBImage” file from this device onto the computer.

Images can be stored in JPEG (.jpg), PNG (.png) or PDF (.pdf) format, selectable in the copyboard settings (“CB Setup”). (See pages E-33, E-40.) The factory default is “JPEG”.

CAUTION

With this function, if the operation for disconnecting the USB connection between the copyboard and computer is performed or the copyboard's power is turned off, the image data in the copyboard's computer storage memory is deleted. Be sure to save important image data on the computer, etc.

Notice

- Only one screen's worth of data can be stored in the copyboard's memory for computer storage. When the copyboard's save operation is performed successively, previous data is overwritten.
- Do not store computer data in the copyboard's memory for computer storage.
- The memory for computer storage cannot be formatted from a computer.
- Do not disconnect the USB cable or access the copyboard while data is being saved after pressing the copyboard's Save  button. Doing so will cause the computer's operation to become unstable.
- Do not press operation buttons on the copyboard while the copyboard's memory for computer storage is being accessed from the computer. Doing so will result in increased time for response between the computer and copyboard, and operations may not be possible.
- When connected to a Macintosh computer, the warning message “The disk was not ejected properly.” is displayed, but the data can be stored normally in the computer's memory.

1

Turn on the copyboard's power and connect the PC dedicated USB port (type B) and computer using the USB cable.

- Usually, with Windows XP/Windows Vista/Windows 7, the standard driver is installed automatically and the copyboard is identified by the computer as a removable device.

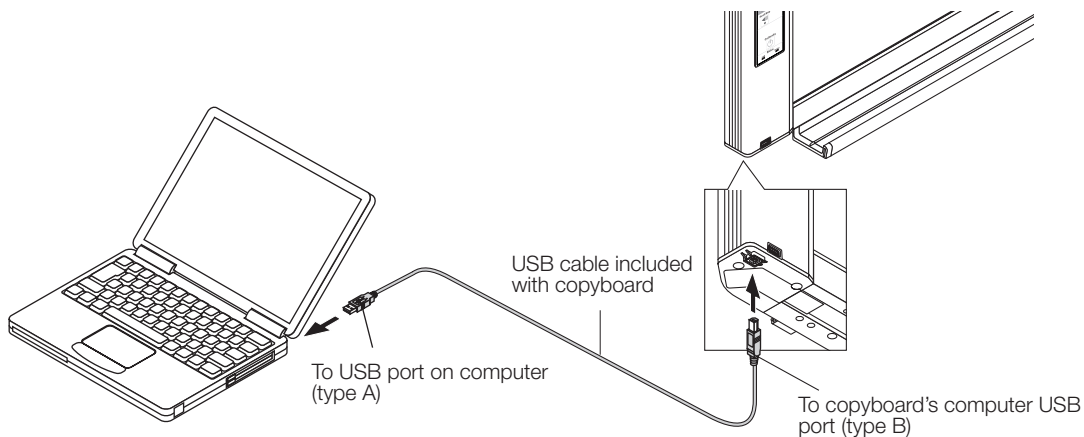

2

Press the Save button to store.



Display window

LEDs flash in circular motion during saving in memory for computer storage

- One sheet's worth of the screen is scanned (scrolled) and storing in the memory for computer storage starts once scrolling stops.
The LEDs on the display window flash in a circular motion during saving in the memory for computer storage.
- When storing is performed using model N-204's consecutive printing function (see page E-18), a consecutive storage number is added after “CBImage”. (Example: For two screens – CBImage-1.jpg, CBImage-2.jpg)

3

On the computer, open “My Computer”, and from there open the copyboard identified as a removable device.

- (1) Double-click the “My Computer” (or “Computer”) icon to open it.
- (2) When the device icon for the copyboard (displayed as a removable disk) is double-clicked, the copyboard’s internal memory opens.
The “CBImage” file is the scanned image file (“.jpg”, “.png” or “.pdf”, according to setting).
 - The “setup” folder contains the simple network settings file.
- (3) Copy the “CBImage” file to [My Documents], etc., on the computer (“.jpg”, “.png” or “.pdf”, according to setting).

To disconnect the USB cable, follow the procedure in step 3 on page E-22.

Note that the image data in the copyboard’s computer storage memory is deleted if the operation for disconnecting the USB connection between the copyboard and computer is performed at this time.

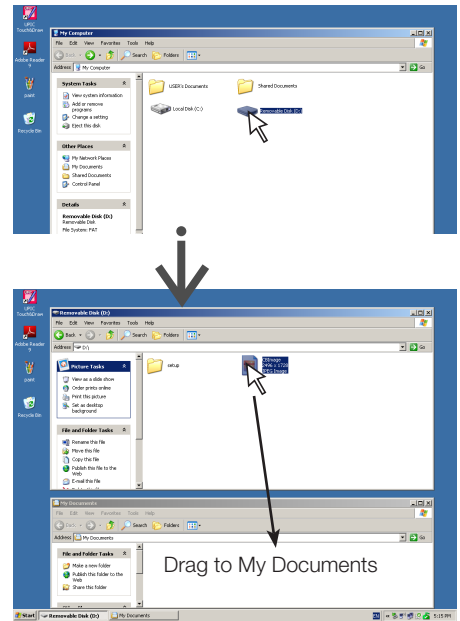

Using the Copyboard Connected to a Network

When connecting to the network the first time

- (1) Make the settings of the IP address, etc., required for connecting the copyboard to the network. See “Simple Network Settings (via USB)” (page E-35).
- (2) Use a commercially available LAN cable (10Base-T or 100Base-TX straight cable) to connect the copyboard’s LAN terminal to the LAN port on a hub, etc.
- (3) Make the copyboard’s network settings or FTP server settings from a web browser. (See “Making Detailed Settings (via LAN)” on page E-37.)

If you plan to store image files on an FTP server, create the folder for storing the files on the FTP server. Ask your network administrator for instructions on settings and creating the folder.

Notice

- Be sure to transfer important image files stored on the copyboard itself to a computer (data backup). If the copyboard should for some reason malfunction, depending on the malfunction the stored data may be lost or become impossible to transfer. Note that PLUS will accept no responsibility whatsoever for loss of data, etc.
- The copyboard will not operate properly if the firewall is activated.

The following explanation assumes that the LAN cable has been connected and the various network settings have been completed.

Saving scanned images on the copyboard or FTP server

Model name: N-20S/N-20W

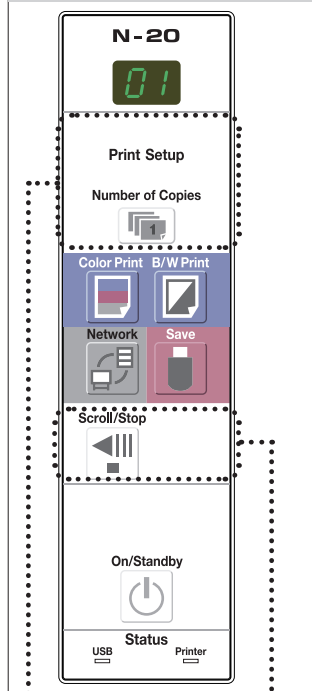

Preparations :

Check that the power plug is connected to a wall power outlet.



Press the **ON/Standby** button to turn on the power.



Note

- When turning on the power after the power plug has been connected or the power has been turned off (set to the standby mode), wait about 5 seconds or more before pressing the ON/Standby button.
- When the ON/Standby button is pressed and the power turns on, the display window’s LEDs light.



Press the **Scroll/Stop** button (for model N-204, the **Scroll/Stop** or **Scroll/Stop** button) to display the screen to be stored.

Model name:
N-20S/N-20W



Model name:
N-204

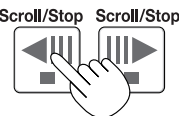

The procedure for displaying the sheet surface to be save is the same as for the printing operation.

See “Basic Printing Operation” on page E-15.

Note

- When saving, the visible image (one screen’s worth) is saved on the copyboard or FTP server.
- When “Board” (network storage memory) is selected as the save to location, approximately 100 image files can be saved.
- It may not be possible to save the edges of the sheet surface. See “About the scanning tolerance range” on page E-5.

continued on next page

3

Press the **Network** button to save the image.



LEDs flash in circular motion during saving

[Display window]

- The scanning operation (scrolling) is performed over one sheet's worth of image, and when scanning stops the data is stored in the save to location set in the network settings.
For instructions on selecting the save to location, see "Network Settings" on page E-42.
- For model N-204, multiple screens can be stored consecutively. (See Page E-18, "Consecutive Printing".)

Note

- Depending on the network communications conditions, some time may be required for identification and storage.
- If "E8" flashes (for about 5 seconds), "Invalid" is set at "Security Setting" → "Network Storage". (See page E-44.)
- If "L1" to "L5" flashes (for about 5 seconds), this indicates that the network settings are incorrect. (See page E-49.)
- If "FL" flashes (for about 5 seconds), there is not enough space in the save to location. Delete image files to provide space. (See pages E-29, E-31.)
- If the ON/Standby button is pressed during the scanning operation, saving is interrupted and the image data scanned up to that point is saved.
To move the sheet surface, wait until scrolling stops, then press the Scroll/Stop button.
- When the Network button is pressed, image files are stored successively in the save to location. When consecutive storing is performed on model N-204, numbers "-1", "-2", "-3" or "-4" are added to the end of the file name. (Example: When two screens are stored consecutively - 20110123_012353-1.pdf, 20110123_012353-2.pdf)
The copyboard's date and time are recorded as the date and time of saved files. For instructions on setting the time, see pages E-12, E-40.

4

When not using the copyboard, press the **ON/Standby** button to turn off the power (standby mode).

On/Standby



Transferring image files to/deleting them from the computer

Image files stored in the folder for saving (“Board” or “FTP Server”) can be transferred to your own computer. The operation differs according to the setting for where scanned images are stored. (See “Network Settings” on page E-42.)

The image files are saved in JPEG (default), PNG or PDF format, according to the image format setting. (See “CB Setup” on pages E-33, E-40.)

The information below must be input to transfer the files.

If you do not know this information, ask your company's network administrator.

Log in to the folder for saving (meaning connect to the communications path): IP address of the copyboard or FTP server

Verification screen:

If the folder for saving is set to “Board” ... User name and password registered at “User Setting”.

If the folder for saving is set to “FTP Server” ... User name and password registered on the FTP server

When the folder for saving is set to “Board”

The scanned images are saved on the copyboard. These images are downloaded (transferred) onto the computer connected on the network. Downloading is possible even when the copyboard is in the standby mode (but not if the copyboard's power is not connected to a power outlet).

1

Launch the web browser on the computer and log into the copyboard.

Input the copyboard's IP address, then press the [Enter] key.

- Upon shipment from the factory and when set to the defaults, the copyboard's IP address has not been set, so logging in is not possible.

The top menu is displayed.

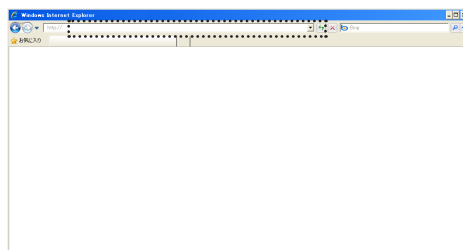

2

Click “Board File List” on the menu.

The verification screen opens.

- No password is set upon purchase. For the user name, input “admin”, then click the [OK] button.
- When a user password is set, input the user name (case sensitive) and password (case sensitive), then click the [OK] button.

If the user name is correct, the verification screen closes and the file list is displayed.

Note

- We recommend setting a user name and password to prevent unwanted persons from logging in. (See “User Setting” on page E-43.)

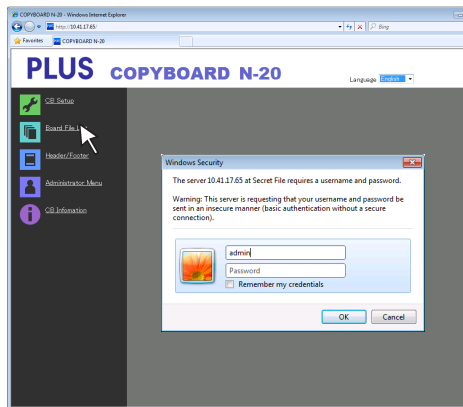

Using the Copyboard Connected to a Network

3

Click the desired date.

- Image files are managed in groups by date (the date the scanned image files were saved). Because of this, display the date list.
- Check that “Download” is selected for the [Download/Delete] selection button. When “▼” is clicked, a pull-down list is displayed. Click [Download].

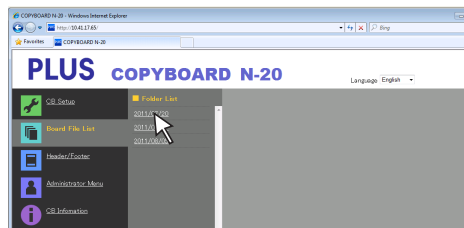

[Download/Delete] selection button

4

From the file list, select the image to be transferred to the computer.

When the radio button is clicked, it is checked and a preview image is displayed.

Download the image onto the computer.

- Click the [Download] button.
- The computer's “Save as ...” screen appears.
- Select the folder for saving, then click the [Save] button.

Downloading starts.

To download other files, click “Return to the File List” to return to the file list, then repeat from step 3.

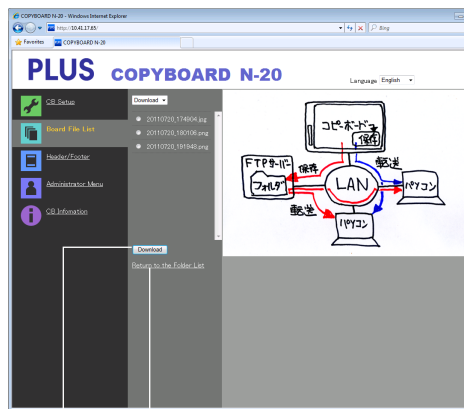
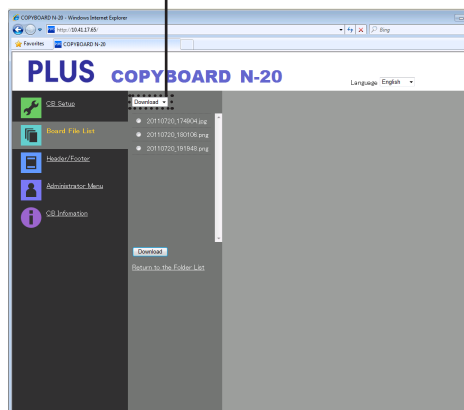

[Download] button (“Return to the File List”)

5

Close the web browser.

Click the web browser's close button (X) to close it.

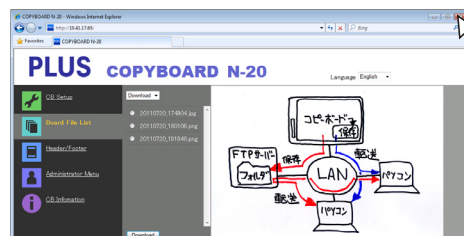

Deleting image files from the copyboard

Notice

- When "Invalid" is set at "Delete User Image Data" in "Security Setting", files cannot be deleted. This can be changed to "Valid" with the administrator's authority. (See page E-44.)

1 Perform steps 1, 2 and 3 on page E-27 to display the file list screen.

2 Select [Delete].

When "▼" on the [Download/Delete] selection button is clicked, a pull-down list is displayed. Click [Delete].

When [Delete] is selected, the radio buttons switch to checkboxes .

[Download/Delete] selection button

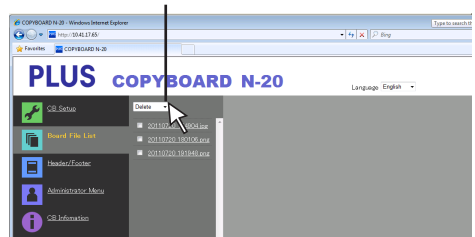

3 Select the image file to be deleted.

To select and delete individual files:

Click the checkbox for the image file to be deleted to check it.

To delete all files:

Click the [Select All] button. All the checkboxes are checked. If there are several files you do not want to delete, uncheck the checkboxes for those files.

To uncheck the checkboxes for all the files, click [Cancel Select All] to uncheck all the checkboxes.

Note

- Images are previewed when their file name is clicked.
- Check the scanned images using their preview images before deleting them.

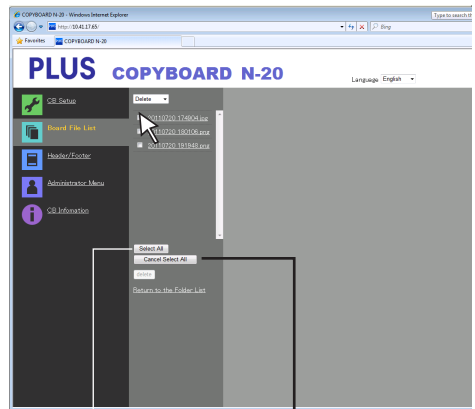

[Select All] button

[Cancel Select All] button

4 Delete the file(s).

Be sure to transfer important image files to a computer before deleting them (data backup). Once deleted, the files cannot be retrieved.

When the [Delete] button is clicked, the image files whose checkboxes are checked are deleted.

- When "Invalid" is set at "Delete User Image Data" in "Security Setting", the message "No delete authority" is displayed, indicating that the files cannot be deleted. (See "Security Settings" on page E-44.)

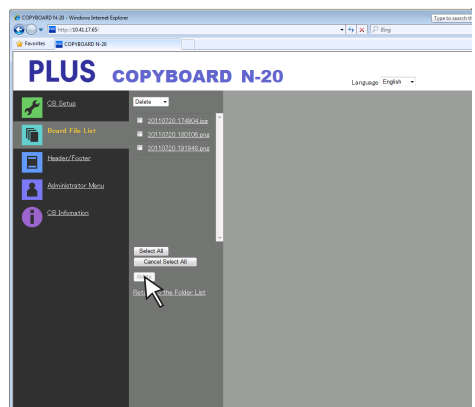

Using the Copyboard Connected to a Network

When the folder for saving is set to “FTP Server”

When the folder for saving is set to “FTP Server”, the scanned images are saved on the FTP server connected on the network. Transfer these images onto the computer connected on the network. The following explains how to transfer the files using Explorer on the computer.

1

Click the computer icon or, from the Start menu, click “Computer”.

Explorer opens.

2

Log in to the FTP server.

Click on Explorer's address field, input the FTP server's IP address after “ftp://”, then press the [Enter] key. The FTP server's verification screen opens.

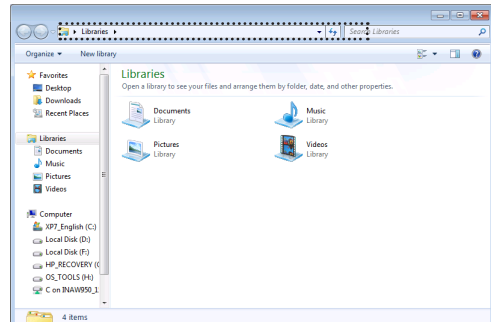

3

Input the required fields on the verification screen.

Input the user name and password registered on the FTP server, then click the [Log In] button.

- Input the user name (case sensitive) and password (case sensitive), then click the [Log In] button.

If the user name and password are correct, the verification screen closes and the file list is displayed.

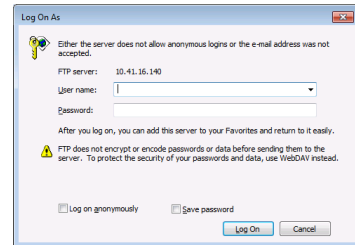

4

Transfer the image file(s) to the computer.

From the FTP server's screen listing the folders/files, select the desired folder(s) or image file(s), right-click the mouse to display a pull-down menu, select “Copy”, then copy the folder(s) or file(s) to My Computer, etc.

Copying is also possible by clicking and dragging.

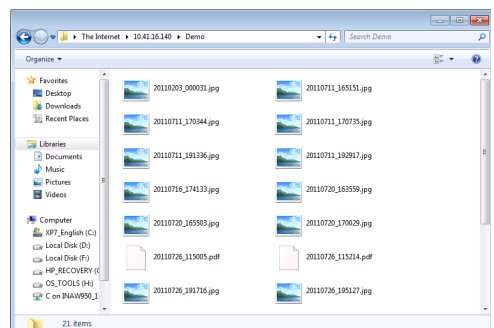

5

Close the Explorer window.

Click the close button (X) on the Explorer window to close Explorer.

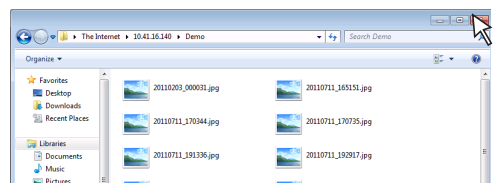

Using the Copyboard Connected to a Network

Note

- Logging in to the FTP server from a web browser
The procedure is the same as for “When the folder for saving is set to “Board”” on page E-27.
However, to log in, input the FTP server’s IP address (input “ftp://”, then input the IP address), and at the verification screen input the user name and password registered on the FTP server.

Deleting image files on the FTP server

At step 4 on the previous page, select the folder(s) or image file(s) to be deleted, right-click the mouse to display a pull-down menu and select “Delete”. At the verification screen, click “Yes”. The folder(s) or file(s) are deleted.

If folder(s) or file(s) cannot be deleted

- Is access to the FTP server’s folder restricted?

Notice

- Be very careful when deleting folders or files from the FTP server.
- Check again before deleting to avoid accidentally deleting other folders or files.

CB Setup and Network Setting Procedure

There are three ways to make the device settings: using the copyboard's operation buttons to make the settings ("CB Setup"), making the settings using a USB connection (simple network settings, and making the settings via LAN (detailed settings: "CB Setup" and "Network Setting").

CB Setup (operating the copyboard's buttons)

Basic setting operation

- Check that the power is on (that the display window is lit).
- When in the "CB Setup" mode, the copyboard will return to the normal mode if no buttons are operated for 10 seconds, so operate the buttons within 10 seconds.

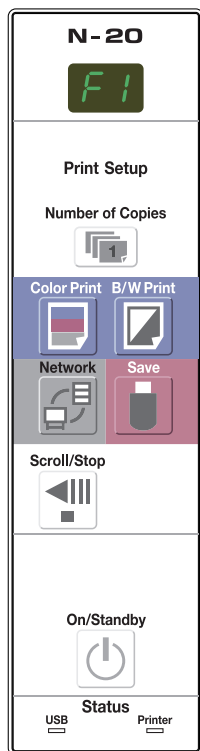

1 Switch to the CB Setup mode.
While pressing the ON/Standby button, press the Number of Copies button, then release the ON/Standby button. The copyboard switches to the CB Setup mode. "F1" appears on the display window. "F1" is the time setting. For instructions on the time setting, see page E-12.

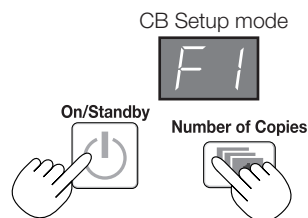

2 Select "the function number", then press the Save button.
Press the Number of Copies button (the function switches each time the button is pressed, returning to F1 after FA) to select the desired function number, then press the Save button to set that function number.
For the item names of the function numbers, see the "Table of Function Numbers and Settings" on the following page.

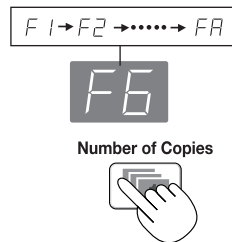

3 Select "the setting", then press the Save button.

Press the Color Print or B/W Print button, check the setting, then press the Save button to set.
Check the setting according to whether the USB and Printer Status indicators are lit or off. See the "Table of Function Numbers and Settings" on the following page.

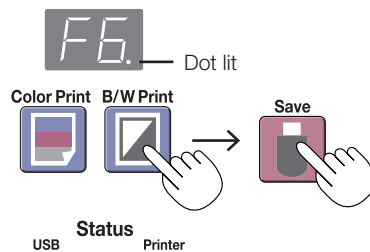

4 Exit the CB Setup mode.
Press the ON/Standby button. The copyboard returns to the normal mode. The display window returns to the number of copies display.

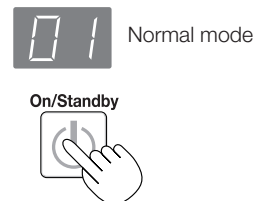



CB Setup and Network Setting Procedure

Table of Function Numbers and Settings

Function Number	Setting Item	Description	Setting	Status Indicators	
F1	Time Setting	The date and time are stamped on the printing paper and recorded in the file information when files are stored.	Year, month, day, hours, minutes	Not lit	
F2	Paper Size	Selection of whether to print in A4 paper size or letter size. • This operates when the copyboard is connected to a printer.	A4*	USB ■ (Lit)	Printer □ (Off)
			Letter	USB □ (Off)	Printer ■ (Lit)
F3	Aspect Ratio Setting	Selection of the image's vertical-to-horizontal ratio (aspect ratio) when printing. Equal Ratio: The image is printed with the same ratio as the copyboard's sheet surface. Compressed: The image is compressed in the horizontal direction to the ratio of A4 or letter size paper for printing (ex: circles become ellipses).	Compressed*	USB ■ (Lit)	Printer □ (Off)
			Equal Ratio*	USB □ (Off)	Printer ■ (Lit)
F4	Color Printing	If this is set to [Invalid], color printing is not possible. Valid: When this is set, color printing is possible. Invalid: When this is set, color printing is not possible.	Valid*	USB ■ (Lit)	Printer □ (Off)
			Invalid	USB □ (Off)	Printer ■ (Lit)
F5	Resolution	Selection of the image file's resolution. Standard: The vertical/horizontal size of the scanned image is set to 1/2. The amount of data is 1/4 that of when "High Resolution" is selected. High Resolution: The image file has the same resolution as the scanned image (vertical/horizontal size of 1/1). The picture quality is better than when "Standard" is selected.	Standard	USB ■ (Lit)	Printer □ (Off)
			High Resolution	USB □ (Off)	Printer ■ (Lit)
F6	Graphics File Format	Selection of the format in which image files are saved. Scanned images are converted into JPEG (extension ".jpg"), PNG (extension ".png") or PDF (extension ".pdf") format.	JPEG*	USB ■ (Lit)	Printer □ (Off)
			PNG	USB □ (Off)	Printer ■ (Lit)
			PDF	USB ■ (Lit)	Printer ■ (Lit)
F7	Header/Footer	Setting of whether or not to output the header/footer information registered on the copyboard. "Off": The header/footer information is not output. "On": The header/footer information is output when printing and when saving image files. Note: • Headers and footers refer to the information at the top and bottom margins, respectively, of printed pages or images. Titles, company names or other characters or images can be inserted so that the same information is provided on all pages. • For instructions on creating and registering headers and footers, see "Creating and Registering Headers and Footers" (page E-47). • Depending on the type of printer, the colors may differ from the actual graphic image.	Off*	USB ■ (Lit)	Printer □ (Off)
			On	USB □ (Off)	Printer ■ (Lit)

continued on next page

CB Setup and Network Setting Procedure

Function Number	Setting Item	Description	Setting	Status Indicators	
F8	Erase Reminder	Setting of whether or not to notify the user that characters or diagrams drawn on the back side of the copyboard's sheet surface have not been erased. This is effective for confidential meetings, etc. Disable: The Erase Reminder function does not work. (Setting upon factory shipment) Enable: When the ON/Standby button is pressed to turn the power off, the display window on the copyboard's operation panel flashes and the copyboard automatically moves to the non-erased surface, after which the power turns off. <ul style="list-style-type: none"> The Erase Reminder function may not work properly due to dirt on the sheet adhesive or marker traces. 	Disable*	USB ■ (Lit)	Printer □ (Off)
			Enable	USB □ (Off)	Printer ■ (Lit)
F9	Time Day Stamp Format	Selection of the format in which the date and time are displayed. Examples of displays: YYYY/M/D 2011/1/23 01:23 DD-MMM-YYYY 23-Jan-2011 01:23 MMM-DD-YYYY Jan-23-2011 01:23	YYYY/M/D*	USB ■ (Lit)	Printer □ (Off)
			DD-MMM-YYYY	USB □ (Off)	Printer ■ (Lit)
			MMM-DD-YYYY	USB ■ (Lit)	Printer ■ (Lit)
FA	Reset Device Settings	This restores the copyboard device settings at F2 to F9 to their defaults (settings upon factory shipment). The settings marked " * " are the defaults. (1) Select FA, then press the Save  button. "FA." is displayed (with the dot lit). (2) Press the Save  button again. The settings are reset.	—	—	—

Simple Network Settings (via USB)

Upon purchase (by default), the copyboard's IP address and subnet mask are not yet set. When first connecting the copyboard to a network to use it, use the simple network settings to set the copyboard's IP address on the network following the procedure below.

Notice

- When making network settings, following the instructions of the network administrator.
- It is not possible to format the computer storage memory from the computer.
- Do not press operation buttons on the copyboard while the computer storage memory is being accessed from the computer. Doing so will result in increased time for response between the computer and copyboard, and operations may not be possible.

1 Turn on the copyboard's power and connect the copyboard's computer USB port for (type B) to the computer using a USB cable.

- Normally, on Windows XP/Windows Vista/Windows 7, the standard driver is installed automatically and the copyboard is recognized by the computer as a removable device.

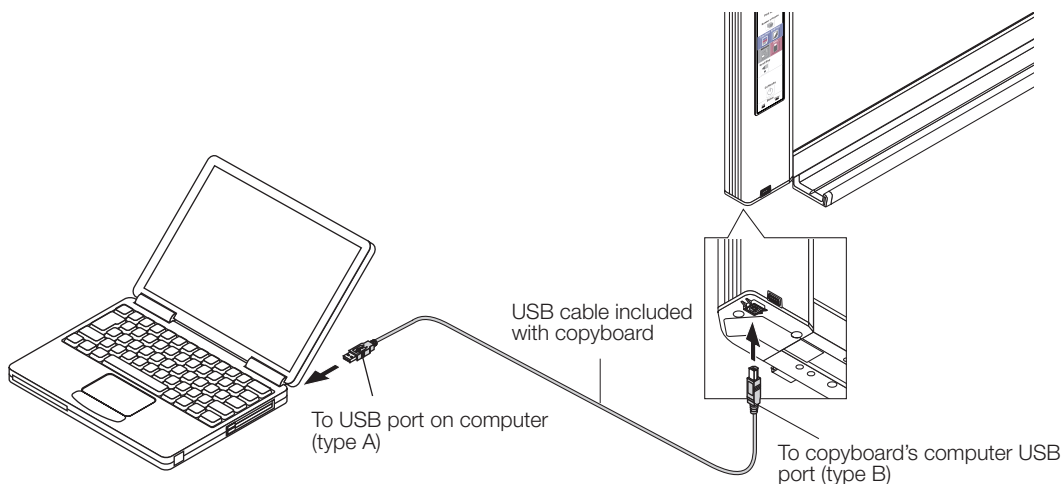

2 Open "My Computer", and in this open the copyboard (removable device).

- 1 Double-click the "My Computer" (or "Computer") icon to open.
- 2 Double-click the copyboard (a device displayed as a removable disk) to open the copyboard's computer storage memory.
 - To check that the copyboard is operating as a device, right-click "My Computer" (or "Computer") to display the menu, then check that "PLUS Copyboard USB Device" is displayed as the disk drive name at "Management" → "Device Manager" for Windows 7 ("Properties" → "Device Manager" for Windows XP).

3 Use a program on the computer (Notepad, etc.) to open the "setting.ini" file in the "setup" folder.

- 1 Double-click the "setup" folder to open it.
- 2 Open the "setting.ini" file (text format) located in this folder using Notepad or another program on the computer and directly overwrite the contents of the settings file.
 - The only characters that can be input are numbers and periods.
Do not insert any spaces. If so, the file will be identified as corrupt when the copyboard is started and the settings will be reset to the defaults.

continued on next page

CB Setup and Network Setting Procedure

Contents upon purchase and when network settings are reset

IP Address=* Input the IP address (fixed).
Subnet Mask=* Input the subnet mask.
Default Gateway=* Input the default gateway if necessary.

Item	Item name	Setting	Default
IP address	IP Address	Any value	Blank
Subnet mask	Subnet Mask	Any value	Blank
Default gateway	Default Gateway	Any value	Blank

4

Save the “setting.ini” settings file, overwriting the previous file.

Save to location: “setup” folder on copyboard (removable disk)

File name: setting.ini

- We recommend making a note of changed settings for future reference.

Once overwriting is completed, the copyboard reboots automatically.

Perform the USB disconnection procedure on the computer (see step 3 on page E-22), then disconnect the USB cable.

5

Check the connection.

- 1 Connect the copyboard to the LAN port on a switching hub, etc.
- 2 Launch a web browser (ex.: Internet Explorer) on a computer connected to network.
- 3 In the address field, input “http://” followed by the IP address that was set, then press the [Enter] key.
If the copyboard’s top screen opens, the copyboard has been correctly connected to network.

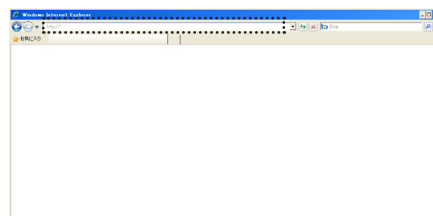

If the copyboard’s top screen does not open

This could be due to one of the following:

- Have you made a mistake inputting the IP address that was set?
- Is the copyboard’s LAN terminal properly connected to a LAN port on the network?
- Is the IP address that was set being used by another device?
- If multiple units of this copyboard are connected, are they connected to the network with the same IP address?
- Is the IP address that was set within the automatic acquisition range of the DHCP of the router, etc.?
- When using a proxy server, add the copyboard’s IP address to the “Exceptions” in the proxy’s settings to set so that the proxy is not used.

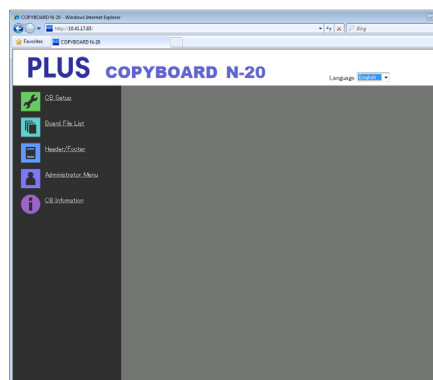

CB Setup and Network Setting Procedure

Making Detailed Settings (via LAN)

Use this procedure to make the copyboard device settings (“CB Setup”), network settings, etc., with the copyboard connected to a local area network (hereafter referred to as “LAN” or “the network”) using a computer’s web browser.

Access authority is required to make the detailed settings. There are three levels of authority – “administrator authority”, “file list browsing authority” and “no authority”, and the selectable menu items (some setting items) are restricted accordingly. Register the administrator and users at “User Setting” on page E-43.

Table of Menu Items and Access Authority Levels

Menu Item	Some Setting Items	Administrator Authority	File List Browsing Authority	No Authority
CB Setup		○	○	○
Board File List	Preview and Download	○	○	—
	Delete	○	—*	—
Header/Footer		○	○	○
Administrator Menu	Network Setting	○	—	—
	User Setting	○	—	—
	Security Setting	○	—	—
	Disk management Setting	○	—	—
CB Information		○	○	○

○ mark: Accessible : — mark: Not accessible

* When the “Delete User Image Data” security setting is set to “Valid”, deleting is possible with file list browsing authority.

Notice

- When connecting the copyboard to the network, be sure to consult the network administrator before making the settings.

Note

- Depending on the network being used, the display speed and button response may be slow and operations may not be performed. If this happens, consult your network administrator. Also, the copyboard may not respond if buttons are operated successively. In this case, wait awhile then operate again. If there is no response after a while, turn off the copyboard’s power, then turn the power back on.
- If the top screen does not display with a web browser, press the [Ctrl] + [F5] keys to refresh the web browser’s screen.
- The copyboard uses JavaScript and cookies. Set the web browser so that these functions will operate.
- The copyboard performs automatic page reading (redirecting). Set the web browser so that this function will operate.

Basic Setting Operations

Here we explain how to display and close the settings screens, using the Internet Explorer web browser as an example.

Preparations:

1. Use a LAN cable to connect the copyboard’s LAN terminal to the LAN port on the switching hub.
2. Turn on the copyboard’s power.



Launch the web browser on the computer connected to the network.

“Page cannot be displayed” may in some cases appear, but simply continue to the next step.

CB Setup and Network Setting Procedure

2

Input the copyboard's IP address.

In the web browser's URL field, input "http://" followed by the copyboard's IP address, then press the [Enter] key.
When the copyboard is connected, the top screen appears.

Connecting the copyboard to the network upon purchase

Upon purchase, the copyboard's IP address and subnet mask are not yet set. Be sure to check the section "Simple Network Settings (via USB)" (see page E-35) and set the IP address, etc.

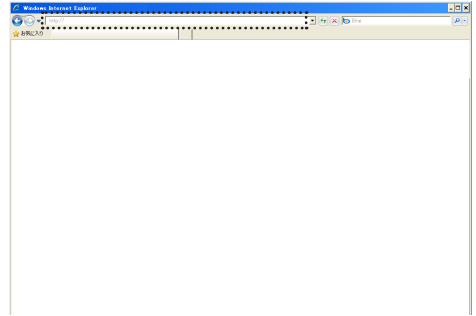

3

From the menu, click the desired setting item.

When setting items for which verification are required are clicked, the user verification screen is displayed.

Input the user name and password, then click the [OK] button.

- No password is set upon purchase.
For the user name, input "admin", then click the [OK] button.
- At the user verification screen, the administrator's user name and administrator's password can also be used for verification.

Once verification is validated, the desired page is displayed.

See the respective pages in this manual for explanations.

- CB Setup (page E-40)
- Board File List (page E-27)
- Header/Footer (page E-41)
- Administrator Menu
- CB Information (page E-45)

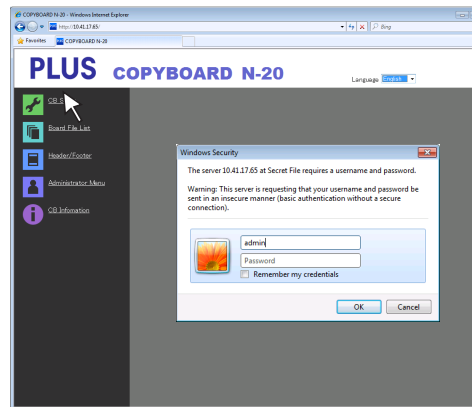

Click "Administrator Menu" to change the settings below.
The menu can be accessed with administrator authority.

- Network Setting (page E-42)
- User Setting (page E-43)
- Security Setting (page E-44)
- Disk management Setting (page E-45)

1. Click "Administrator Menu".
The administrator verification screen appears.
2. Input the administrator's user name and administrator's password, then click the [OK] button.
 - No password is set upon purchase.
For the user name, input "admin", then click the [OK] button.Once verification is validated, the administrator authority menu is displayed.
Click the desired menu item to display the settings page.

Note

- The user name and password are case sensitive. Be sure to input them properly.

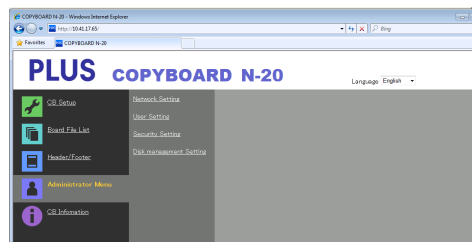
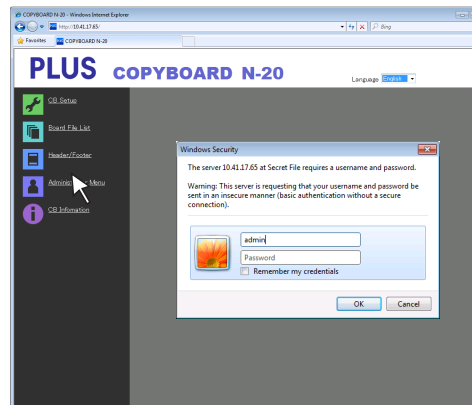

CB Setup and Network Setting Procedure

4

Make the changes or settings.

The screen at the right is an example of what may be displayed, here showing the “CB Setup” page.

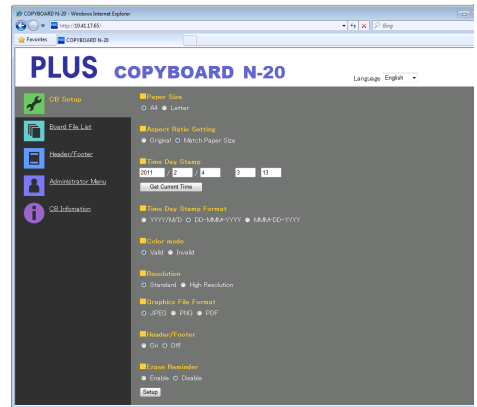

Selecting and inputting

Radio buttons

One of the selection items can be selected. When is clicked, it switches to .

Input boxes

When a box is clicked, the arrow cursor switches to the “|” character input cursor. Input characters in the same way as you would on a computer.

- The characters that can be input are restricted according to the item’s type of setting. (See page E-43)

Browse and Upload buttons

See “Header/Footer”. (Page E-41)

Setup button

When clicked, the settings/changes are sent to the copyboard, overwriting previous settings.

Once overwriting is completed, the “CB Setup” page switches to the “Setup is completed” character display.

- If the IP address in the network settings, etc., has been changed, the copyboard reboots. (See page E-42.)

After making settings or changes, be sure to click the “Setup” button to overwrite the previous settings on the copyboard.



Setup

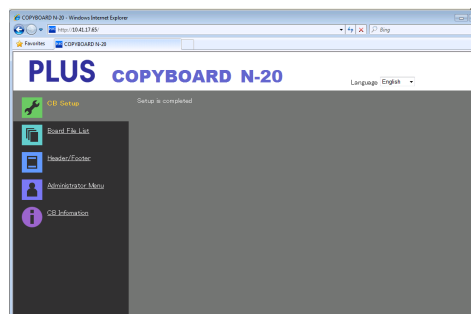

5

Close the web browser.

Click the web browser’s close button (X) to close it.

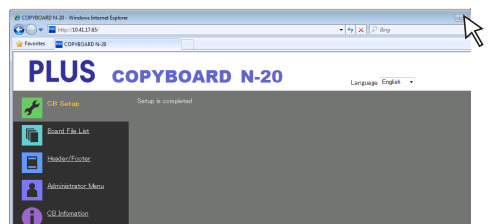

CB Setup and Network Setting Procedure

CB Setup

This is the page where the copyboard's various functions are set and changed. The settings are the same as on "Table of Function Numbers and Settings" in the section on making the settings operating the copyboard's buttons. (For instructions on displaying the screen, see "Basic Setting Operations" step 3 on page E-38.)

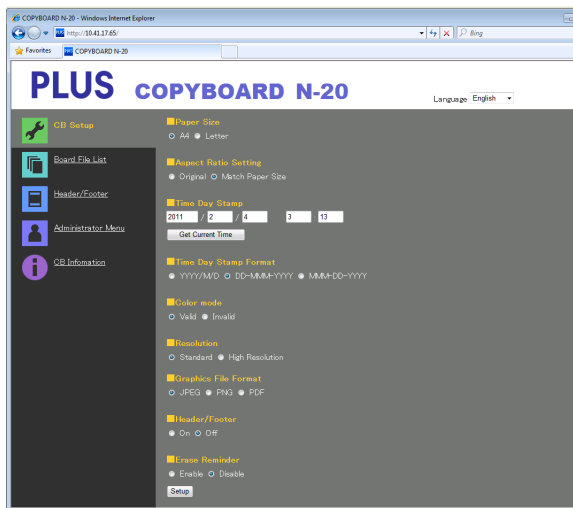

Copyboard Setting Item	Setting/Description	Default
Paper size	Select the printing paper size.	A4
Aspect Ratio Setting	Select the aspect ratio for printing.	Match to printing paper size
Time Date Stamp	<p>Set the copyboard's date and time. Input as follows: Year: 4 digits, Month: 2 digits (Ex.: 03 for March), Day: 2 digits (Ex.: 06 for the 6th), Hours: 2 digits in 24-hour mode (Ex.: 14 for 2 pm, 06 for 6 am), Minutes: 2 digits (Ex.: 00 for 0 minutes)</p> <ul style="list-style-type: none"> Do not insert spaces. If the date and time setting values are incorrect, an error message is displayed. <p>Get Current Time: When the "Get Current Time" button is clicked, the display switches to the computer's current time. This eliminates the need to make the current date and time setting.</p>	
Color Printing	Color printing can be set to Valid or Invalid.	Valid
Resolution	Select the resolution at which scanned images are saved.	Standard
Graphics File Format	Select the format in which scanned images are saved.	JPEG
Header/Footer	Set whether or not to output the header/footer information registered on the copyboard.	Disable (Off)
Erase Reminder	Set the erase reminder function.	Disable
Setup	<p>When the [Setup] button is clicked, the above settings/changes are sent to the copyboard, overwriting previous settings. Once overwriting is completed, the "CB Setup" page switches to the "Setup is completed" character display.</p>	

CB Setup and Network Setting Procedure

Header/Footer

This is the screen for registering headers and footers on the copyboard and checking the image. (For instructions on displaying the screen, see “Basic Setting Operations” step 3 on page E-38.)

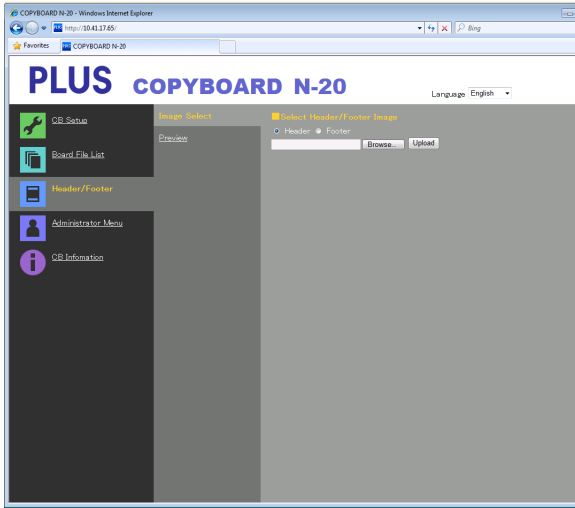
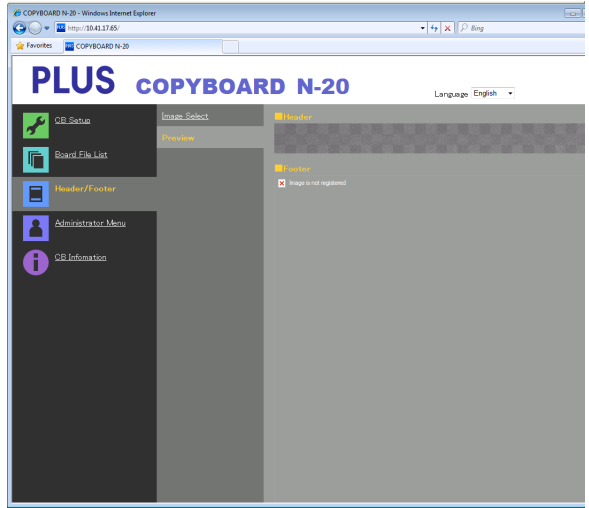

Image Select screen



Preview screen

Image Select/Preview Item	Setting/Description	Default
Select Header/Footer Image	Select whether the image to be registered on the copyboard is a header or footer. Click the radio buttons to select. <ul style="list-style-type: none"> For instructions on creating images, see page E-47. 	Header
Browse	When the [Browse] button is clicked, the computer's "Browse Files" screen opens. Select the image, then click the [OK] button to set it.	—
Upload	This uploads the selected header or footer image to the copyboard. When the [Upload] button is clicked, uploading starts. <ul style="list-style-type: none"> If an image is already registered on the copyboard, that image is overwritten. 	—
Preview	This displays a preview of the header or footer image registered on the copyboard.	—

CB Setup and Network Setting Procedure

Network Setting

Make the settings for the copyboard's IP address, the FTP server's IP address, etc.

(For instructions on displaying the screen, see "Basic Setting Operations" step 3 on page E-38.)

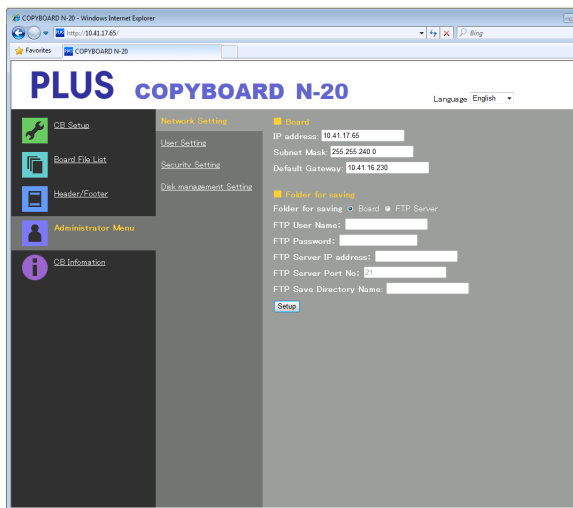

Network Setting Item	Setting/Description	Default
IP address	Change the copyboard's IP address. Use a fixed IP address for the copyboard. When connecting to a network using the DHCP of a router, etc., change the IP address to one that is outside of the automatic acquisition range	Any value
Subnet Mask	Set the copyboard's subnet mask.	Any value
Default Gateway	Set the copyboard's default gateway.	Any value
Folder for saving	Set the folder in which the copyboard's scanned images are saved. Board: The images are saved on the copyboard. FTP Server: The images are saved in the specified folder on the FTP server.	Board
FTP User Name	This is the user name registered on the FTP server. This is required for the copyboard to log in to the FTP server and save image files.	Blank
FTP Password	This is the password registered on the FTP server. This is required for the copyboard to log in to the FTP server and save image files.	Blank
FTP Server IP Address	Input the FTP server's IP address.	Blank
FTP Server Port	This is the FTP server's standard control port number. Normally use with this number. If the FTP server's port number has been changed, change this following the instructions of the network administrator.	21
FTP Save Directory Name	Input the name of the subfolder in the FTP server folder in which image files are saved.	Blank
Setup	When the [Setup] button is clicked, the above settings/changes are sent to the copyboard, overwriting previous settings. Once overwriting is completed, the display switches to the "Setup is completed. Rebooting. Wait for a while." character display. If the IP address, subnet mask or default gateway have been changed, the copyboard automatically reboots. During rebooting, the copyboard's display window LEDs flash in circular motion. Wait until they turn off.	—

CB Setup and Network Setting Procedure

User Setting

Set the user name and password required for administrator and user verification and the number required for resetting the network settings.

(For instructions on displaying the screen, see “Basic Setting Operations” step 3 on page E-38.)

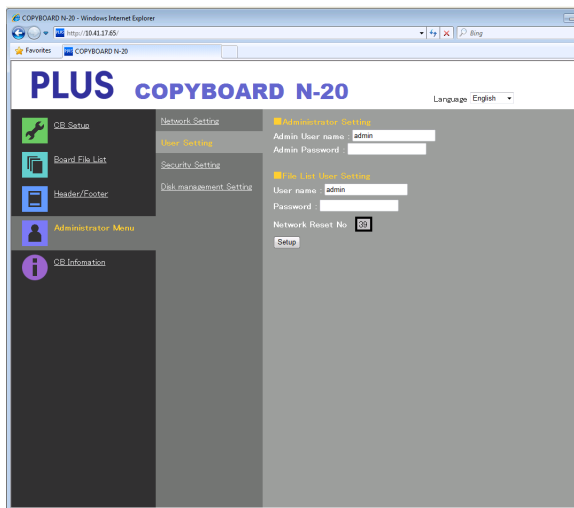

User Setting Item	Setting/Description	Default
Admin User name	Set the administrator's user name. • Input using no more than 14 characters. The name will be case sensitive for verification.	admin
Admin Password	Set the administrator's password. • Input using no more than 14 characters. The password will be case sensitive for verification.	None
User Name	Set the user name. The limit to the number characters that can be input is the same as for the administrator's user name.	admin
Password	Set the password. The limit to the number characters that can be input is the same as for the administrator's password.	None
Network Reset No.	This is the number used for resetting the network settings. (See page E-46) Note: Be sure to copy down this number. It will be required if you forget the administrator's password.	—
Setup	When the [Setup] button is clicked, the above settings/changes are sent to the copyboard, overwriting previous settings. Once overwriting is completed, the “CB Setup” page switches to the “Setup is completed.” character display.	—

Note

- Copy down the user settings in case you should forget them.

Admin User name

Admin Password

User Name

Password

Network Reset No.

CB Setup and Network Setting Procedure

Security Setting

These security settings can be made to restrict access to setting items.

For this page, the security settings page cannot be displayed unless [Administrator Menu] is clicked and the administrator's user name and password are input on the verification screen. (For instructions on displaying the screen, see "Basic Setting Operations" step 3 on page E-38.)

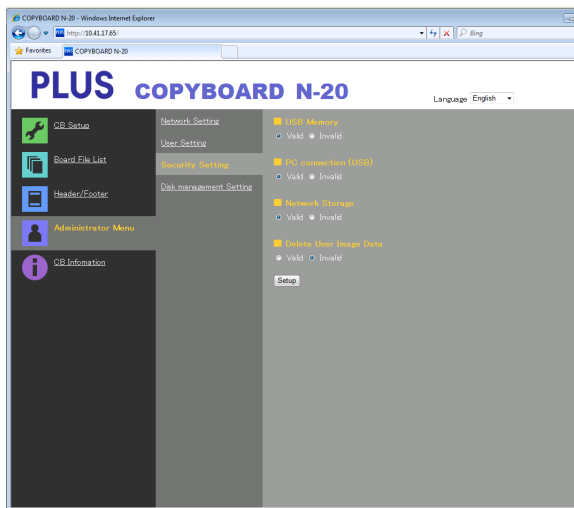

Security Setting Item	Setting/Description	Default
USB Memory	Set whether or not to enable or disable saving on USB memory devices.	Valid
PC connection (USB)	Set whether or not to enable or disable saving in a computer storage memory.	Valid
Network Storage	Set whether or not to enable or disable transfer of image files to network storage (folder for saving: "Board" or "FTP Server") to a computer or FTP server. Notice: <ul style="list-style-type: none"> When set to "Invalid", the network storage memory is formatted. Transfer important image files to a computer before setting this. 	Valid
Delete User Image Data	Set whether to enable or disable the file list "Delete" function with file list browsing authority. When set to "Invalid", the image files stored on the copyboard cannot be deleted.	Valid
Setup	When the [Setup] button is clicked, the above settings/changes are sent to the copyboard, overwriting previous settings. Once overwriting is completed, the "CB Setup" page switches to the "Setup is completed." character display.	—

CB Setup and Network Setting Procedure

Disk management Setting

The amount of disk space used can be checked, the disk can be checked and the disk can be formatted here.
 (For instructions on displaying the screen, see “Basic Setting Operations” step 3 on page E-38.)

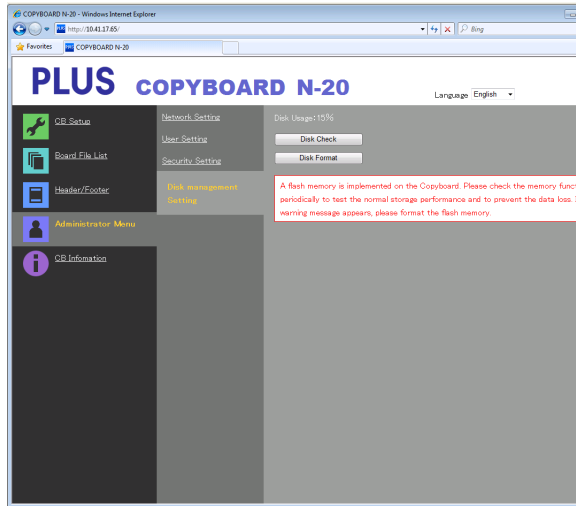

Disk Management Setting Item	Setting/Description	Default
Disk Usage	This displays the amount of network storage memory used (in percentage).	—
Disk Check	When the [Disk Check] button is clicked, checking of the network storage memory starts. When checking is completed, the results of the check are displayed. If a warning is displayed, format the disk.	—
Disk Format	When the [Disk Format] button is clicked, the disk is formatted. Notice: <ul style="list-style-type: none"> Transfer important image files to a computer before formatting. 	—

CB Information

This displays the contents of the detailed settings made on the copyboard and the copyboard's firmware version.
 Note that the passwords are not displayed.

(For instructions on displaying the screen, see “Basic Setting Operations” step 3 on page E-38.)

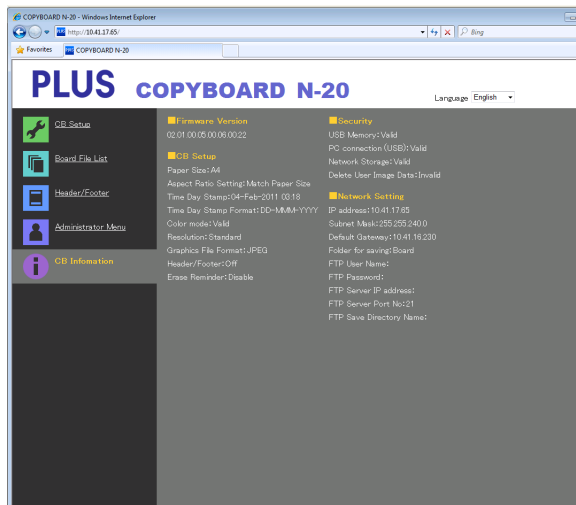

CB Setup and Network Setting Procedure

Resetting the Network Settings

Operate the buttons on the copyboard to reset the network settings to their defaults.

Setting items that are reset: Admin User name, Admin Password, User Name, Password, IP Address, Subnet Mask, Default Gateway, Folder for saving, FTP User Name, FTP Password, FTP Server IP Address, FTP Server Port, FTP Save Directory Name

Notice

- Once reset, the network settings cannot be restored.

1. While pressing the ON/Standby button, press the Network button.

The copyboard switches to the network settings reset mode and "00" flashes on the display window.

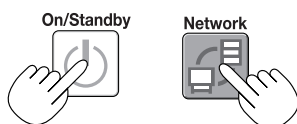

2. Press the Color Print (Increase) or B/W Print (Decrease) button to display the network reset number.

- The network reset number can be viewed when User Setting is selected with administrator authority.

The display switches as follows each time the Color Print (Increase) button is pressed:

01 → 02 → → 99 → 00 → 01

The display switches as follows each time the B/W Print (Decrease) button is pressed:

99 → 98 → → 01 → 00 → 99

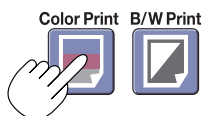

3. Press the Save button to enter.

To cancel, press the ON/Standby  button.

When the reset number matches, "LA" flashes for 5 seconds on the display window, then the copyboard's network settings are overwritten with the default values and the copyboard automatically reboots.

If "LE" flashes for 5 seconds then stops flashing, remaining lit, the reset number is wrong.

- Press the ON/Standby  button to cancel, then start over from step 1.



CB Setup and Network Setting Procedure

Creating and Registering Headers and Footers

The header/footer function allows you to superimpose your company name, logo, etc., at the top or bottom of scanned images for printing or display. The date and time are printed at the top right of the header.

Creating header and footer images

Use your image software to create a JPEG file.

Create the image with the resolutions below.

Max. size for header images: 1248 × 110 dots * Image format: JPEG

Max. size for footer images: 1248 × 40 dots Image format: JPEG

* This is sometimes expressed as “pixels”.

Note

- Even for image data whose resolution is within the allowable limits, it may happen that the top and bottom of the image are not displayed.

Image display position

Images are displayed at roughly the center in the horizontal direction. In the vertical direction they are positioned next to the scanned image area. Consider this when creating images with less than the maximum size.

Suggestions on creating images

Scan the logo data with an image scanner, save this on the computer as image data, then crop or reduce its size to fit within the specified resolution and save this new data.

Use Windows Paint, etc., to paste images, input characters, etc., to create the image.

When saving, save in JPEG format with a size within the maximum size.

Registering created images on the copyboard

Example: Here we explain how to register a header image. Use the same procedure to register footer images.

1. Open the “Header/Footer” screen at Detailed Settings (via LAN). (See page E-37.)

2. Header/Footer Image Select

- When a preview is selected, click “Image Select” on the submenu.

Click the “Header” radio button.

3. Select the header image you have created.

Click the [Browse] button to display the computer’s “Browse Files” screen.

Select the image file to be registered as the header, then click the [OK] button. The file name is displayed.

4. Click the [Upload] button to upload the image to the copyboard.

When uploading is completed, “Completed successfully” is displayed.

At this time, “HF” flashes on the copyboard’s display window (for 5 seconds, after which it stops flashing, remaining lit).

If “Data size is too large” is displayed, the image cannot be registered.

Close the web browser, then adjust the image file’s size.

Note

- When headers or footers are registered, the header/footer function is set to “Enable”.

Click “Preview” to check the registered image.

This completes registration. Close the web browser.

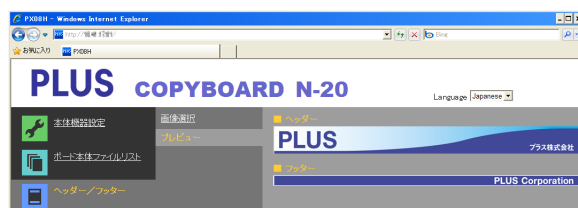
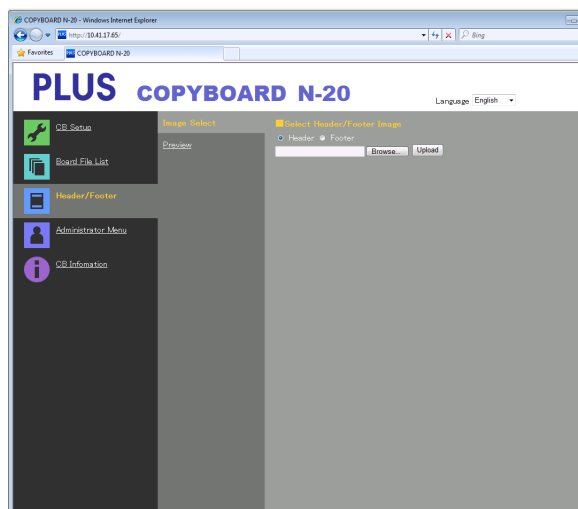

Meaning of Error Messages

If any of the following flashing indications appear in the display window of the control panel, please check the matters described below.
Error messages flash for 5 seconds, then stop flashing, remaining lit.

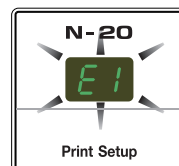







Copyboard (main unit) related errors

Error Display Number	Problem and Solution		
E1	Printer not connected No printing paper Printer problem	<ul style="list-style-type: none"> Is the printer cable connected? Is power being supplied to the printer? When the printer uses an AC power adapter, is the cable disconnected somewhere? Has paper been set in the printer? Is the printer error indicator flashing (or lit)? 	<ul style="list-style-type: none"> Connect the printer properly and switch on the printer power. Turn the power of the printer off and then on again, and load the printer with A4 or letter size paper. Read the printer instruction manual.
E2	USB Memory not recognized	<ul style="list-style-type: none"> Is the USB memory unformatted. Is a USB memory that is not supported by the copyboard being used? Is the USB memory device plugged in fully? Is the USB memory damaged? 	<ul style="list-style-type: none"> This unit supports the FAT and FAT 32 formats. Perform the formatting with the personal computer. The file formats for USB memory devices that can be used on this copyboard are FAT and FAT32. Please check the operation with a personal computer. —
E3	Memory storage problem	<ul style="list-style-type: none"> An error occurred during memory storage. 	<ul style="list-style-type: none"> Please perform memory storage again. Do not insert or remove the USB memory during processing.
E4	Reading problem	<ul style="list-style-type: none"> There is a lighting fault of the reading light source, or a read signal error. 	<ul style="list-style-type: none"> Unplug the power plug from the power outlet and then plug it in again.
E5	System error	<ul style="list-style-type: none"> There is a memory or internal fault. 	<ul style="list-style-type: none"> Unplug the power plug from the power outlet and then plug it in again.
E8	Security protection	<ul style="list-style-type: none"> The operation is set to "Disable" in the security settings. 	<ul style="list-style-type: none"> Change the setting of the desired item to "Enable". (See page E-44.)
E9	Color printing prohibited	<ul style="list-style-type: none"> Coloring printing is set to "Disable". 	<ul style="list-style-type: none"> Change the color printing setting to "Enable". (See pages E-33, E-40.)
U5	USB memory not connected	<ul style="list-style-type: none"> USB memory device is not plugged into the main unit. 	<ul style="list-style-type: none"> Plug the USB memory device into the USB port.
FL	Memory is full	<ul style="list-style-type: none"> There is no available space. 	<ul style="list-style-type: none"> Please delete unnecessary data using a personal computer (See Page E-21, E-29).
EL	An unsupported printer is connected	<ul style="list-style-type: none"> A printer that is not supported by the copyboard has been connected. 	<ul style="list-style-type: none"> Press the ON/Standby ϕ button and switch off the power. When a record is required, switch on the power and save to USB memory.
EH	Time setting error	<ul style="list-style-type: none"> An error has occurred when setting the time. 	<ul style="list-style-type: none"> Start over and set the proper date and time.
When the "USB" letter display is flowing...Warning that disconnection of USB memory has been forgotten		<ul style="list-style-type: none"> Did you press the ON/Standby ϕ button while the USB memory device was plugged into the main unit? 	<ul style="list-style-type: none"> A USB memory device is plugged into the main unit. When the USB memory device is disconnected, the power will be switched off and the unit will enter the standby mode.

If the problem persists, please contact your nearby PLUS Corporation sales office, dealer, or store.

Meaning of Error Messages

Network (main unit) related errors

Error Display Number		Problem and Solution	
	LAN cable disconnected	<ul style="list-style-type: none"> No cable is connected to the LAN terminal. 	<ul style="list-style-type: none"> Connect the LAN cable properly.
	FTP server recognition error	<ul style="list-style-type: none"> The user name or password is wrong. 	<ul style="list-style-type: none"> Input the correct user name and password. (See page E-42.)
	FTP server connection failure	<ul style="list-style-type: none"> The FTP server's IP address is wrong. 	<ul style="list-style-type: none"> Consult the network administrator then set the FTP server's IP address. (See page E-42.)
	FTP server writing failure	<ul style="list-style-type: none"> There is no FTP storage folder. 	<ul style="list-style-type: none"> Consult the network administrator then set the FTP storage folder.
	IP address not set, other network error	<ul style="list-style-type: none"> An error other than one indicated by L1 to L4 has occurred. 	<ul style="list-style-type: none"> Unplug the power cord from the power outlet then plug it back in.
	Network settings reset error	<ul style="list-style-type: none"> An error has occurred in resetting the network settings. 	<ul style="list-style-type: none"> The network reset number is wrong. Input the correct number and repeat the operation. (See page E-43.)
	Header/footer writing error	<ul style="list-style-type: none"> This occurs when the size of the inserted image is too large. 	<ul style="list-style-type: none"> Adjust the image then repeat the operation.

Network-related errors indicate errors in access between the copyboard and network. In some cases they are related to the network system, so consult the network administrator. If the problem persists, it may be due to a copyboard malfunction. Contact your store of purchase.

Troubleshooting

Please check the following matters before making a request for servicing.

	Condition	Please Check
Copyboard Related	Pressing the ON/Standby ⏻ button does not switch on the power.	<ul style="list-style-type: none"> Check whether the cable of the AC power adapter is disconnected from the DC connector of the Copyboard or the wall outlet. (Unplug the AC power cable from the outlet, wait several seconds and then plug it back into the outlet again.)
	Writing on the sheet is not erased with the eraser.	<ul style="list-style-type: none"> Was a marker other than a dedicated marker used?
	Parts of characters and lines are not displayed on printouts or in image data.	<ul style="list-style-type: none"> Blurred characters and thin lines may not be displayed on printouts or in image data.
	Scanned copy (image) is dirty, Erase Reminder function is activated even when sheet is erased with the eraser	<ul style="list-style-type: none"> Is there marker residue or substantial quantities of refuse on the sheet? (If the sheet is dirty, moisten a soft cloth with water, wring well, then wipe the sheet in a stroking manner.)
	When the copyboard and PC are connected, the PC does not recognize the copyboard	<ul style="list-style-type: none"> Check whether the copyboard is in an operable condition, and whether the USB cable is connected properly. Is the copyboard connected to the PC via a USB hub? (Connect the copyboard directly to the USB port of the PC.)
	The date is not updated.	<ul style="list-style-type: none"> The copyboard's battery is dead. Contact your store of purchase.

* If the problem persists, please contact your nearby PLUS Corporation sales office, dealer, or store.



	Condition	Please Check
Printer Related	The copyboard's power turns on, but the printer's power does not.	<ul style="list-style-type: none"> Check whether the printer's power plug (DC plug) is securely inserted. If the power still does not turn on, disconnect the AC adapter box and check whether the printer's AC power adapter side plug is unplugged from the AC power adapter. (For some printers it is directly mounted.)
	Printing is not possible when Color Print (or B/W Print) button is pressed.	<ul style="list-style-type: none"> Check that the power cable of the printer and the printer cable are securely connected. Check that the printer power indicator is lit. Check whether the copyboard's status indicators and the printer's error indicator are lit. If an error is displayed on the copyboard's display window, see page E-48. (Please see the printer instruction manual for information about printer errors.)
	The paper feed is abnormal.	<ul style="list-style-type: none"> Possible causes include damp paper, overly thin or thick paper, only one sheet of paper is set, and a curved setting of the paper. (Please see the instruction manual for your printer.)
	An altered color is printed, not the specified color.	<ul style="list-style-type: none"> Please replace the print cartridges with new ones.
	There is no printing.	<ul style="list-style-type: none"> Check that the print cartridge is properly set. Check that the print cartridge is not plugged.
	<ul style="list-style-type: none"> Print is very pale, there are white lines on it, or page is dirty. Printed colors are very different from those of the markers that were used. 	<ul style="list-style-type: none"> Is the print cartridge's nozzle partially choked? Make a test print and check the conditions of the nozzle.

Also see the descriptions of error indications at “Network (main unit) related errors” on page E-49.

Condition		Please Check
Network related	Network communications not possible	<ul style="list-style-type: none"> • Is the LAN cable properly inserted? • The LAN cable could be defective. Use a straight cable (10Base-T or 100Base-TX compatible) to connect the copyboard to the network. • Set the IP address and subnet mask at “Simple Network Settings (via USB)”. * Be sure to check with the network administrator before making the various settings.
	Cannot log in.	<ul style="list-style-type: none"> • Is “Caps Lock” set on the computer’s keyboard while inputting the user name and password?

Test Printing

1) With the copyboard’s power on (with the display window lit), press the Number of Copies button repeatedly to display “ P” on the display window.

2) Press the Color Print () button for a color print, the B/W Print () button for a black-and-white print.

* Test printing starts.

Check the print

- Is the each color line printed uniformly?
- Are there missing dots, pale lines, lines with thinner ink than others, etc.?

Remedy

- If the nozzle is partially choked, clean it.
- If the quality of the print does not improve even though the nozzle has been cleaned, wipe off the ink on the surface of the nozzle.

For details, see the “User’s Guide” included with the printer.

* Please see your printer manual for information about printing problems, printer maintenance, and details related to printing.

Updating the copyboard’s internal program

See the PLUS website for instructions on updating the program and to download the latest program.

Specifications

BOARD TYPE (Model name)		Standard (N-20S)	Wide (N-20W)	4-screen (N-204)
Form	Installation method	Self-standing (T-shaped legs), or wall mounting		
	External dimensions (T-shaped legs*1)	W1480 × D675 × H1947*2 mm	W1980 × D675 × H1947*2 mm	W1480 × D675 × H1947*2 mm
	Main unit weight	20 kg*3	25 kg*3	25 kg*3
	T-shaped legs weight	12.5 kg		
BOARD	Panel Size	H910 × W1300 mm	H910 × W1800 mm	H910 × W1300 mm
	Effective reading size	H900 × W1280 mm	H900 × W1780 mm	H900 × W1280 mm
	Number of Pages	2		4
	Paging	Endless in one direction (Horizontal scrolling)		Bi-directional, endless (Horizontal scrolling)
	Drive method	Sheet movement		
	Reading method	CIS (Contact Image Sensor)		
	Reading illumination light source	RGB LED		
	Reading resolution	Main scanning direction (vertical sheet surface) 1.92 dots/mm (50 dpi or equivalent) Sub scanning direction (horizontal sheet surface) 1.92 dots/mm (50 dpi or equivalent)		
Interface	Board	File format	JPEG, PNG, PDF	
		Screen size	Standard type: 2458 × 1728 dots (fixed) Wide type: 3418 × 1728 dots (fixed)	
	External memory	Type	USB Flash memory	
		Compatible FAT types	FAT 16, 32	
		Interface	USB1.1 or USB2.0 *4	
	Network	LAN port	RJ-45 (10Base-T/100Base-TX)	
	Printing	Printing resolution	300 dpi or equivalent	
No. print colors		16 or grayscale		
Printer interface		Conforming to USB 2.0 standards		
Added functions	Clock	Used for the timestamp and for file dating properties		
	PC connection	Images can be acquired and device settings made via USB (using a browser)		
Power supply	AC power adapter	Input : AC100–240V/50–60 Hz, Max 0.75 A Output : DC 12 V, 3.0 A		
	Power consumption	In standby: 3 W, During operation: 12 W (not including printer)		
Operating conditions	Temperature:	10–35°C		
	Humidity:	30–85% (No condensation)		
Miscellaneous	Ruled lines	50 mm cross-ruled squares		
	Miscellaneous	Dedicated markers (black, red, blue, and green)		
Operating environment	OS	Fully IBM PC/AT compatible computer equipped with standard USB port XP (Home Edition /Professional Edition, Service Pack 2 or greater)/ Vista (32-bit version)/Windows 7 (32- or 64-bit version) Or, Apple Macintosh computer with standard USB port Mac OS X 10.5 or greater		
	Web browser	Windows: Internet Explorer 8.0 or greater Macintosh: Safari 5 or greater * Enable JavaScript.		

Remarks

*1: The height is adjustable at 1747, 1847 and 1947 mm.

*2: The value indicated for “H” (height) is the maximum height.

*3: Not including the weight of the printer.

*4: USB memory device not included. The memory capacity corresponds to 32GB or less.

- Please note that for quality improvement purposes, specifications and design are subject to change without prior notice.

Connections and Wiring Diagram

- The connections and wiring diagram below is included here for checking the connections.

[Copyboard and Printer Connections Diagram]

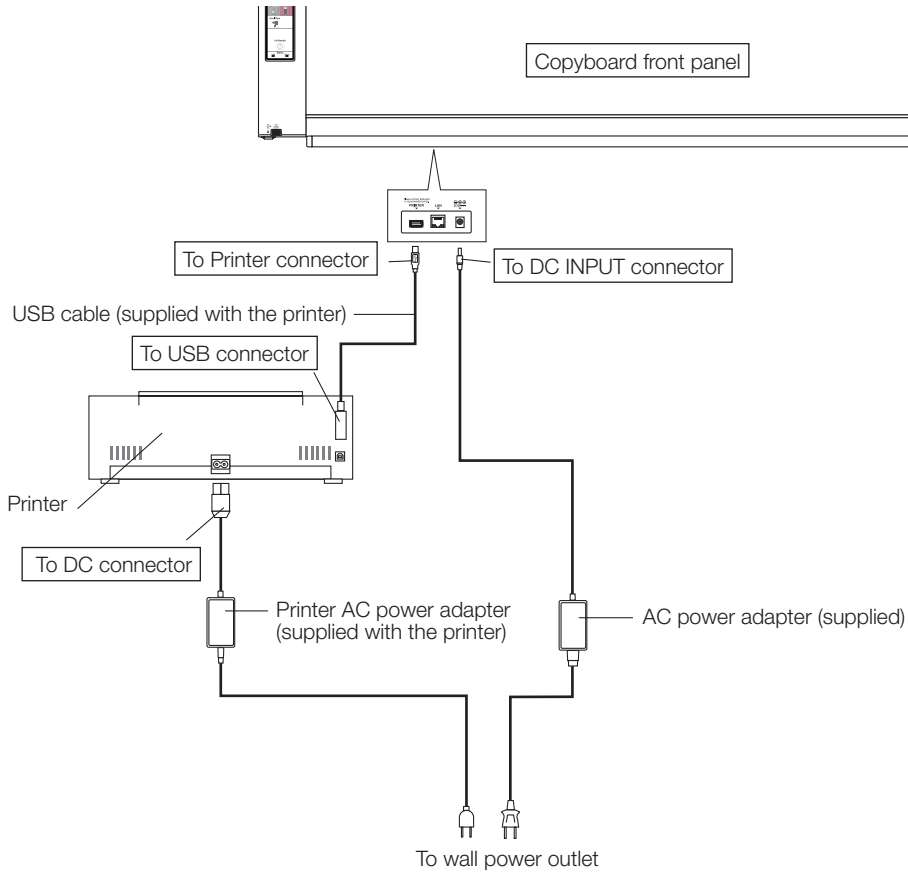

* Appearance of printer is for illustration purposes.

Note

- The AC power adapters of accessories and printers that have been verified to be operation many differ from the ones shown on the connections diagram (they may be of the built-in or mounted-on type).

PLUS Corporation

ISO14001 certification.

©2011, PLUS Corporation

26-4606-11C